

64

A THESIS

ENTITLED

'STUDIES IN NITROXIDE RADICAL CHEMISTRY'

presented to The University  
of Stirling for the degree of  
Doctor of Philosophy

by

ROBERT LYLE CRAIG

1973

ProQuest Number: 13917064

All rights reserved

INFORMATION TO ALL USERS

The quality of this reproduction is dependent upon the quality of the copy submitted.

In the unlikely event that the author did not send a complete manuscript and there are missing pages, these will be noted. Also, if material had to be removed, a note will indicate the deletion.



ProQuest 13917064

Published by ProQuest LLC (2019). Copyright of the Dissertation is held by the Author.

All rights reserved.

This work is protected against unauthorized copying under Title 17, United States Code  
Microform Edition © ProQuest LLC.

ProQuest LLC.  
789 East Eisenhower Parkway  
P.O. Box 1346  
Ann Arbor, MI 48106 – 1346

## ACKNOWLEDGEMENTS

It is a pleasure to record my appreciation of the support of my supervisor, Dr. J. S. Roberts. His guidance, assistance and enthusiasm in this subject have been a source of constant encouragement to me over the last three years.

I am also grateful to Dr. J. F. P. Richter (I.C.I. Ltd., Corporate Laboratory) for friendly advice and assistance, particularly during the course of my stay at Corporate Laboratory.

From time to time during the course of this work, I have been fortunate in obtaining the support of a number of colleagues. Acknowledgement is thus due to Dr. J. M. Key (I.C.I. Ltd., Corporate Laboratory) for assistance in polymerisation techniques, Dr. M. I. Page for assistance in the treatment of the kinetic data, Dr. F. G. Riddell for assistance with some n.m.r. data and to Dr. W. B. Motherwell for many stimulating discussions.

Particular mention is due to Drs. P. and J. Murray-Rust for their invaluable X-ray structure analysis of the product B.

In addition, the assistance of the technical staffs of the Chemistry Departments of Stirling and Glasgow Universities is gratefully acknowledged.

Finally, I should like to acknowledge the co-operation of I.C.I. Ltd. (Corporate Laboratory) during the course of this work.

## CONTENTS

	Page
Introduction .....	1
References .....	18

### SECTION I

#### "The Synthesis of some Polyfunctional Bicyclic Nitroxide Radicals"

Discussion .....	23
Experimental .....	49
References .....	67

### SECTION II

#### Chapter 1 "The Thermal Stability of some Alkyl t-Butyl Nitroxide Radicals"

Discussion .....	71
Experimental .....	144
References .....	172

#### Chapter 2 "The Thermal Rearrangement of N-(1,1-dimethylallyl)-O-(3,3-di- methylallyl)-N-t-Butylhydroxylamine"

Discussion .....	176
Experimental .....	201
References .....	211

INTRODUCTION.

The origin of the term 'radical' can be traced as far back as the early nineteenth century when chemists such as Berzelius, Gay-Lussac and Liebig were tackling the then immense problems presented by the complex structures of organic compounds. Working with hydrogen cyanide, Gay-Lussac and Thénard found that the CN combination could be transferred from compound to compound without its breaking apart into individual carbon and nitrogen atoms. Such a group of two or more atoms that remained in combination while being transferred from one molecule to another was termed a radical from the Latin word for 'root'. It was believed that organic molecules might be constructed out of a limited number of these 'roots'.

The chemistry of radicals, as we know it today, advanced little until the start of the twentieth century when in 1900 the Russian-American chemist Gomberg obtained coloured solutions of a triphenylmethyl 'half-molecule'. Such a compound resembled one of the old radicals dissociated from a molecule and was therefore termed a 'free radical'.

It was appreciated at that time that the presence of an unpaired electron would result in instability and only in special cases such as the triphenylmethyl radical where the unpaired electron could be distributed over the entire molecule would stability be obtained. Subsequent research on free radicals served to substantiate this conclusion.

It is therefore not surprising that one initially finds it difficult to rationalise the existence of stable dialkyl nitroxide radicals.

Although the first organic nitroxide, namely porphyraxide (1) was discovered by Piloty and Schwerin<sup>1</sup> in 1901, it was not until 1959 that Russian workers<sup>2</sup> obtained the first totally aliphatic nitroxide radical (2). Thus it appeared that there existed a class of

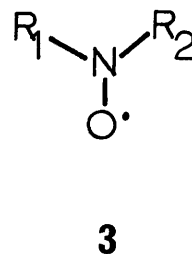
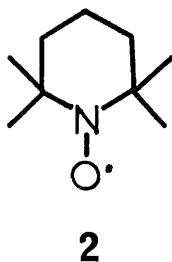
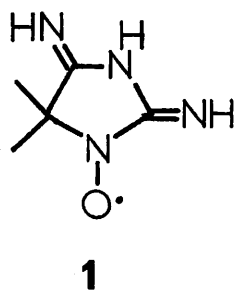

organic free radicals (3) which was unprecedented in that stability was inherently associated with the N-O moiety and not a result of conjugation with unsaturated groups. In this respect nitroxides can be conveniently considered as organic derivatives of nitric oxide which is itself a relatively stable free radical.

Before proceeding further, it must be stressed that the subject of stability in chemistry, particularly with regard to free radicals, is a complex one. Free radical chemistry has, since its inception suffered from an unsatisfactory usage of the terms 'reactivity' and 'stability'. Such terms are, strictly speaking, meaningless unless a frame of reference is properly defined. It would be quite wrong to think of nitroxide radicals as being inert; as with any other class of organic compound, under certain conditions, they are

extremely reactive. For example they react readily with alkyl radicals and can be oxidised and reduced by suitable reagents. However, as organic free radicals, they are relatively unique in showing little tendency to dimerize, to undergo hydrogen abstraction (at least in their ground state) or to react with oxygen. One further point which will be elaborated upon later in this introduction is that the stability of nitroxide radicals is very much dependent upon the substituents on nitrogen ( $R_1$  and  $R_2$  in 3).

Nevertheless, it is largely as a result of the relative stability of suitably substituted nitroxides that we have witnessed the tumescent growth in nitroxide radical chemistry over the last decade. Besides the intense interest shown in the intrinsic theoretical and spectroscopic aspects of these species, their relative stability has allowed them to have a range of applications normally not afforded to free radicals. For instance, probably the most significant application lies in their use in biochemical spin-labelling<sup>3</sup> which is briefly discussed in Section I. A further important application is in the fast-expanding spin-trapping technique<sup>4</sup> discussed briefly in Chapter 1 of Section II. Moreover, they have stimulated commercial interest as a result of their antioxidant properties<sup>5</sup> and therefore their applicability in the stabilization of organic monomeric and polymeric systems.

To date, several reviews on nitroxide radical chemistry have appeared in the literature<sup>6,7,8,9</sup> and no attempt will be made here to reiterate well-documented

facts. Instead, the function of this introduction will be twofold in first providing the reader with the salient facts necessary for an appreciation of the ensuing discussions and secondly to highlight aspects of the subject which are particularly relevant to the content of this thesis.

Nitroxide radicals of the general formula (3) are essentially quadrivalent compounds of nitrogen. The bonding in the N-O moiety is best described by reference to the partial molecular orbital diagram shown in Fig. 1<sup>10</sup>. The bonds to nitrogen are considered to

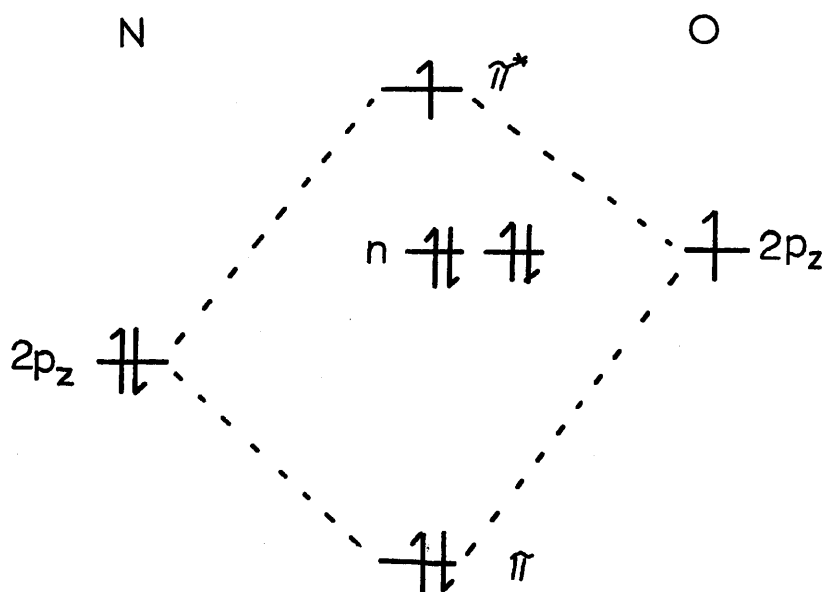
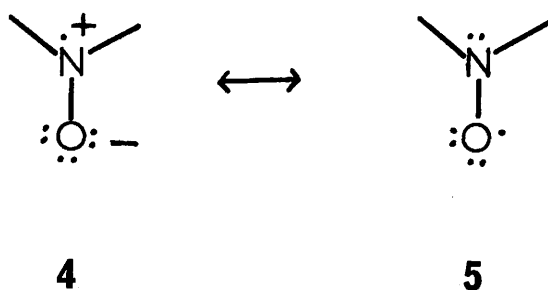

Fig.1

be  $sp^2$  hybridised. Overlap of one of these hybrids with a p orbital ( $p_x$  or  $p_y$ ) on oxygen constitutes a bond. Overlap of the  $2p_z$  atomic orbitals of nitrogen and oxygen produces the  $\pi$  and  $\pi^*$  bonding and antibonding



orbitals respectively. Two electrons occupy the  $\pi$  bonding orbital while the unpaired electron occupies the  $\pi^*$  antibonding orbital. This description accounts for a net bonding effect between nitrogen and oxygen in terms of a two-centre three-electron bond. For convenience, nitroxides are generally represented by the valence bond structures (4) and (5).



This qualitative picture of the bonding in nitroxides has been corroborated by the theoretical work of Kikuchi<sup>11</sup> who has carried out LCAO-SCF-MO calculations with a CNDO/2 approximation. There is presently however some doubt as to the distribution of spin density in nitroxide radicals. From an analysis of various spectroscopic parameters, Stone and McConnell<sup>12,13</sup> concluded that 70-90% of the unpaired spin density resided on nitrogen. However, recent MO calculations using the INDO method suggest that the spin density is greater on oxygen (70%) than on nitrogen<sup>14</sup>. Possibly ab initio calculations with large basis sets will be necessary to decide this question.

Armed with a knowledge of the nature of the bonding

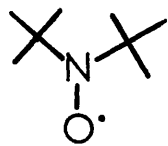

6

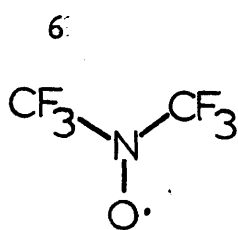

7

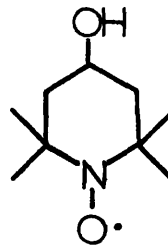

8

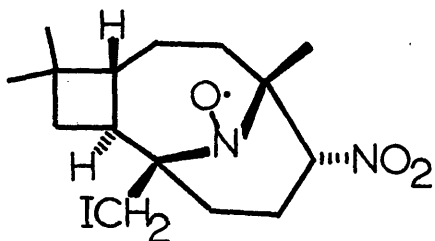

9

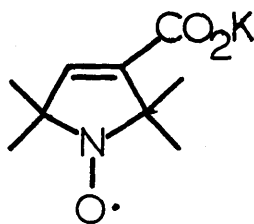

10

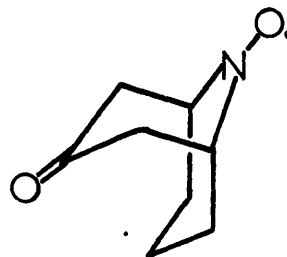

11

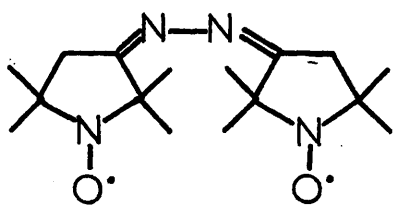

12

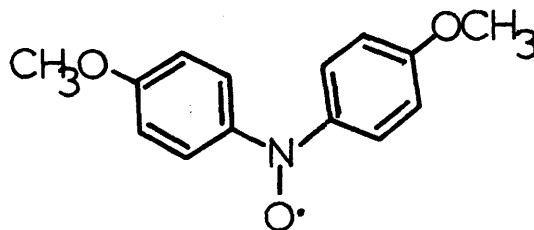

13

Compound	$r_{\text{NO}} (\text{\AA})$	$\angle \text{CNC}$	Angle between NO bond & CNC plane	Ref.
6*	1.28	$136^\circ$	assumed planar	15
7*	1.26	$121^\circ$	$22^\circ$	16
8	1.29	$125^\circ$	$16^\circ$	17
9	1.31	$121^\circ$	$24^\circ$	18
10	1.27	$115^\circ$	$0^\circ$	19
11	1.29	$114^\circ$	$30^\circ$	20
12	1.27	$117^\circ$	$0^\circ$	21
13	1.23	$124^\circ$	$0^\circ$	22

Table 1

\* Electron diffraction measurement

in the N-O moiety, the physical and related spectroscopic properties can now be discussed with reference to a number of nitroxide structures as outlined in Table 1. The structural parameters for these species have been obtained by X-ray or electron diffraction techniques.

The average N-O bond length of 1.29<sup>o</sup>Å for the aliphatic nitroxides is consistent with a two-centre, three-electron bond (bond lengths for N-O and N=O are 1.44<sup>o</sup>Å and 1.20<sup>o</sup>Å respectively). The CNC angle, while normally of the order of 120-125<sup>o</sup>, shows some variation according to the particular structural constraints of the molecule. For example the angle in di-t-butyl nitroxide (6) is larger than normal at 136<sup>o</sup> probably to reduce non-bonded interactions between the t-butyl groups. Moreover, the smaller bond angles in (10), (11) and (12) (115<sup>o</sup>, 114<sup>o</sup> and 117<sup>o</sup> respectively) probably reflect the geometrical requirements of the five-membered cyclic and bicyclic structures.

The question of the geometry of the radical centre has for some time been the centre of speculation. It is apparent from the structures described on Table 1 that the angle which the N-O bond subtends with the CNC plane varies from 0<sup>o</sup> to 24<sup>o</sup> corresponding to a planar or pyramidal configuration respectively in the solid state. In the solid state, it would appear that di-alkyl nitroxides generally possess pyramidal geometry. However, in solution their spectroscopic properties can be explained in terms of either a planar or rapidly inverting pyramidal species. Theoretical calculations<sup>23, 24</sup> on the nitroxides (7) and (14) predict structures in which the pyramidal

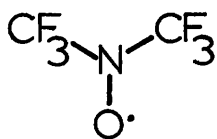

7

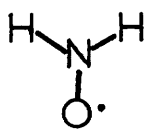

14

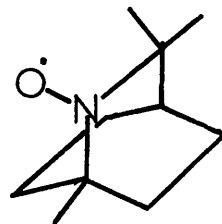

15

form is slightly more stable and in which the rate of inversion is extremely fast. Some light has been shed on this uncertainty by the recent results of Rassat and Rey<sup>25</sup> based on INDO calculations to determine the long range hyperfine coupling to the  $\delta$ -hydrogens in the symmetrical bicyclic nitroxide (15). Their results are consistent with a rapidly inverting pyramidal N-O group in which the out of plane angle of the lowest energy conformation is  $35^\circ$ .

The infra red spectra of nitroxide radicals shows a weak absorption at ca.  $1350\text{cm}^{-1}$ , which has been attributed to the N-O stretching frequency on the basis of labelling studies<sup>26</sup>. This is compatible with the three-electron bond between nitrogen and oxygen. In practice, however, this absorption is of little utility since it is weak and often masked by stronger absorptions such as those of the bending modes of gem-dimethyl groups at  $1360$  and  $1385\text{cm}^{-1}$ .

Di-t-alkyl nitroxides give rise to two bands in the ultra violet at about  $230\text{nm}$ . ( $\epsilon$  ca. 2500) and  $410-450\text{nm}$ . ( $\epsilon$  ca. 10). The latter band, which gives nitroxides their characteristic orange/red colour, has been attributed to an  $n \rightarrow \pi^*$  transition on the basis of solvent polarity effects<sup>27</sup>. Correspondingly, the intense band at ca.

230nm. has been assigned to the  $\pi \rightarrow \pi^*$  transition.

Recent results from photoelectron spectral studies of nitroxide radicals show that these species have a very small first ionization potential arising from the unpaired  $\pi^*$  electron<sup>28</sup>.

By far the most diagnostic tool which is of general applicability is e.p.r. spectroscopy. In solution, di-t-alkyl nitroxides give rise to a 1:1:1 triplet arising from the hyperfine interaction of the unpaired electron with the nitrogen nucleus. The coupling constant  $a_N$  is normally 14-17 oersteds for dialkyl nitroxides. The g factor for nitroxide radicals is usually about 2.0060 which, in accordance with expectations<sup>29</sup>, is slightly larger than the free electron value of 2.0023. The  $a_N$  value has considerable diagnostic value since it is influenced by conjugative and inductive effects of the groups  $R_1$  and  $R_2$  (3) attached to nitrogen. Thus whereas the  $a_N$  value of di-alkyl is about 15 oersteds, aryl alkyl nitroxides have  $a_N$  values of about 12.5 oersteds and acyl alkyl nitroxides (16) have low  $a_N$  values of about 7.5

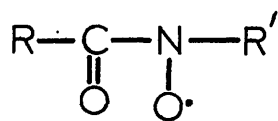

16

oersteds<sup>30</sup>.

While e.p.r. is the key technique in the analysis of nitroxide radicals, very often small couplings to other

protons are not well resolved, especially in the more complex structures. In this respect, the use of n.m.r. has found increasing application largely as a result of the pioneering work of Kreilick<sup>31,32</sup>. Normally, dilute solutions of free radicals such as nitroxides do not give resolved n.m.r. spectra as a result of slow spin exchange relative to the n.m.r. time scale. Resolved spectra can be obtained in concentrated solution (ca. 3M) in a diamagnetic solvent or in a paramagnetic solvent<sup>32</sup> in which the free electron has a short spin-lattice relaxation time and/or a short spin exchange time. With rapid electron spin relaxation, the n.m.r. spectrum consists of a single paramagnetic shifted line for each group of equivalent protons in the molecule. The relationship between the paramagnetic shift of the absorption relative to the same nucleus in a diamagnetic derivative  $\Delta H$ , and the hyperfine coupling constant  $a_i$  is given by :-

$$a_i = \frac{\Delta H}{(\gamma_e/\gamma_n)g\beta H/4kT}$$

where  $\gamma_e$  and  $\gamma_n$  are the gyromagnetic ratios of the electron and the nucleus,  $k$  is Boltzmann's constant,  $T$  is the absolute temperature and  $\beta$  is the Bohr magneton. The power of this method is exemplified by reference to the recent work of Forrester et. al.<sup>33</sup>. From the n.m.r. spectra of a series of 1-and 2-naphthyl-t-butyl nitroxides, these workers obtained the proton coupling constants which were not resolved in their complex e.p.r. spectra. A computerised reconstruction of the e.p.r. spectrum of t-butyl-8-t-butyl-2-naphthyl nitroxide (17) using the

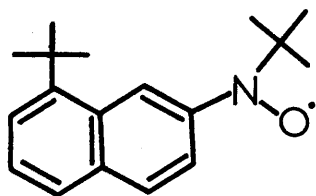

17

coupling constants obtained from the n.m.r. and e.p.r. spectra was in excellent correspondence with the observed e.p.r. spectrum.

As expected from the dipolar nature of the N-O moiety, nitroxide radicals possess a significant dipole

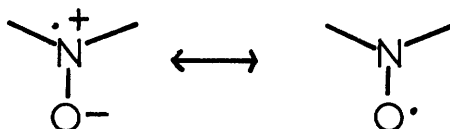

moment (3.14D).<sup>7</sup> A knowledge of this parameter can prove invaluable in establishing the conformation of cyclic nitroxides. A recent example from work carried out in these laboratories is the case of the bicyclic keto nitroxide (18)<sup>34</sup>. A dipole moment of 5.2D for this

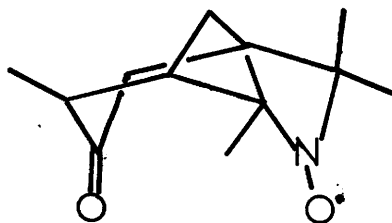

18

molecule was consistent with a chair-chair conformation either with an axial N-O bond or a slight distortion of the piperidinoxy ring.

One further distinctive feature of nitroxide radicals is their mass spectra which generally show an  $[M+1]^+$  ion in addition to the molecular ion  $M^+$ . The former species has been attributed to hydrogen abstraction by the radical from traces of water in the mass spectrometer. Loss of a methyl radical from the  $[M+1]^+$  ion in di-*t*-alkyl nitroxides gives rise to a distinguishing  $[M-14]^+$  ion<sup>35</sup>.

As stated earlier in this introduction, although the nitroxide moiety is an intrinsically stable group, the overall stability of nitroxide radicals is very much dependent upon the nature of the attached groups. For example, aromatic nitroxides such as *t*-butyl-phenyl nitroxide (19) are unstable because the aromatic group

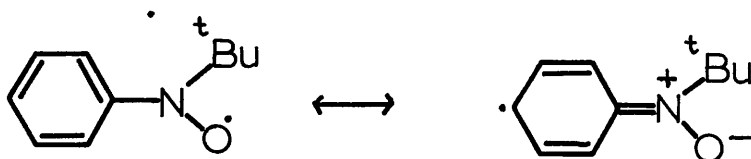

19

permits distribution of the unpaired spin density onto the carbon atoms of the ring which therefore become reactive sites<sup>36</sup>. Di-alkyl nitroxides are generally stable if the carbon atoms adjoining the nitroxide moiety are fully substituted, i.e., if as in diethyl nitroxide (20) there exist  $\beta$ -hydrogen atoms, then rapid disproportionation



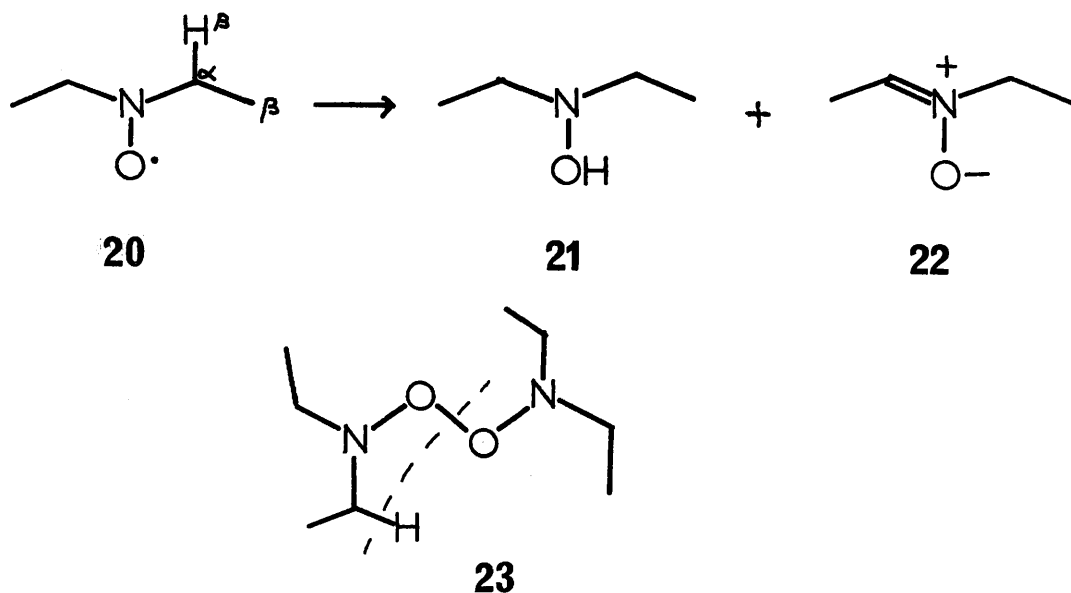

takes place to the corresponding hydroxylamine (21) and nitronium ion (22). Recent results of Ingold *et. al.*<sup>37</sup> on the kinetics of this reaction suggest that the mechanism involves an initial reversible equilibrium formation of the dimer (23) from which disproportionation takes place. Cases do exist however in which nitroxides with  $\beta$ -hydrogen atoms are stable to such disproportionation. For example, the bicyclic nitroxide (24)<sup>38</sup> is stable and nitronium ion formation is precluded by Bredt's rule whereas steric

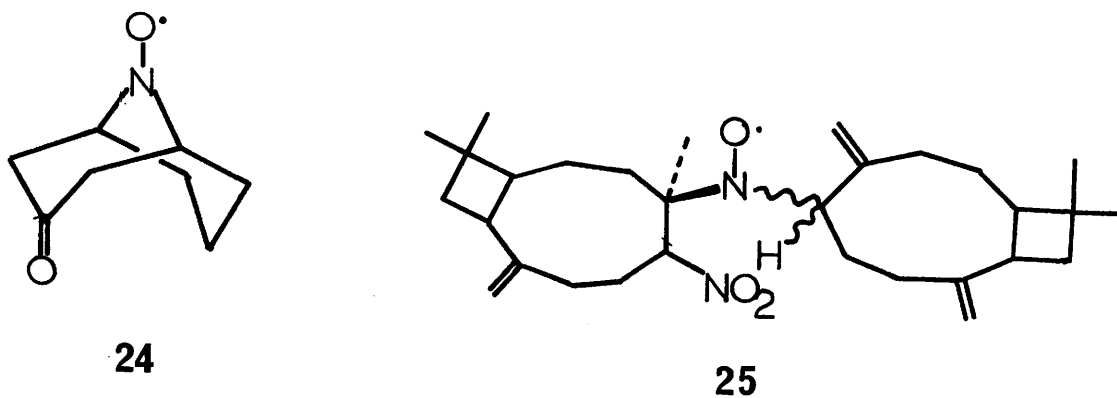

screening of the  $\beta$ -hydrogen atom in (25) imparts stability

towards disproportionation<sup>39</sup>.

As will become apparent in Section II of this thesis, even this substitution rule is not in itself a prerequisite for nitroxide radical stability. For example, 2,2,6,6-tetramethyl-4-oxopiperidine-1-oxyl (26) undergoes decomposition by a mechanism which involves abstraction by the nitroxide group of a hydrogen atom which is

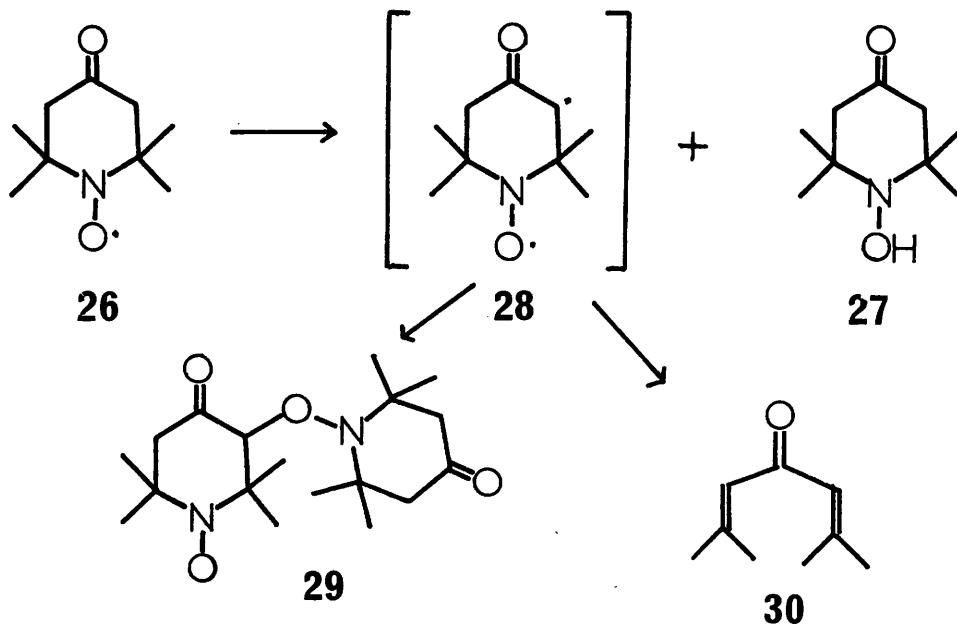

'activated' by the carbonyl group. This forms the hydroxylamine (27) and the intermediate (28) which can subsequently be trapped by another nitroxide to yield the product (29)<sup>40</sup>. Decomposition at higher temperatures (e.g. refluxing benzene) results in the formation of phorone (30).

The marked influence of substituents on the reactivity of the nitroxide group is exemplified by the fast-expanding chemistry of fluorinated nitroxides. For example, bis-trifluoromethyl nitroxide (7)<sup>41,42</sup> and its bis-functional

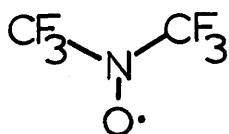
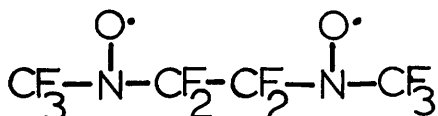
**7****31**

analogue perfluoro-2,5-diaza-hexane-2,5-dioxy (31)<sup>43</sup> possess a much greater reactivity than their di-alkyl analogues. In particular they readily attack nitric oxide and hydrogen atom donors. The bis-nitroxide (31) has found particular application as a polymer cross-linking agent.

Although the photochemistry of nitroxide radicals has received relatively scant attention, Keana et. al.<sup>44</sup> have shown that photolysis of the nitroxide (32) in toluene

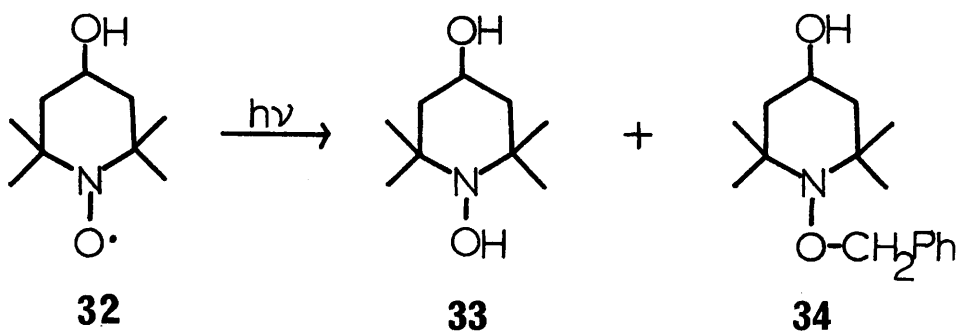
**32****33****34**

solution produces the hydroxylamines (33) and (34).

Hence the  $n \rightarrow \tilde{\pi}^*$  excited state of nitroxide radicals is much more reactive towards hydrogen abstraction than is the ground state.

While stable nitroxide radicals are relatively inert to a wide variety of frequently encountered conditions such as dilute acid, dilute base and borohydride reduction, under certain circumstances they are extremely reactive.

Thus nitroxides can be reduced to the corresponding hydroxylamine or amine depending on the reducing agent or, in the case of hydrogenation, on the catalyst. For example powerful reducing agents such as zinc in acetic acid, hydrogen iodide and Raney nickel catalysed hydrogenation yield amines while reagents such as hydrazine, lithium aluminium hydride and hydrazobenzene produce the corresponding hydroxylamines<sup>8</sup>.

Nitroxides can be oxidised by strong acids in non-aqueous media to form the very reactive immonium oxide salts<sup>8</sup>. For instance, the reaction of the nitroxide (26) with aprotic acids such as trifluoro- or trichloroacetic acid in benzene results in disproportionation to the

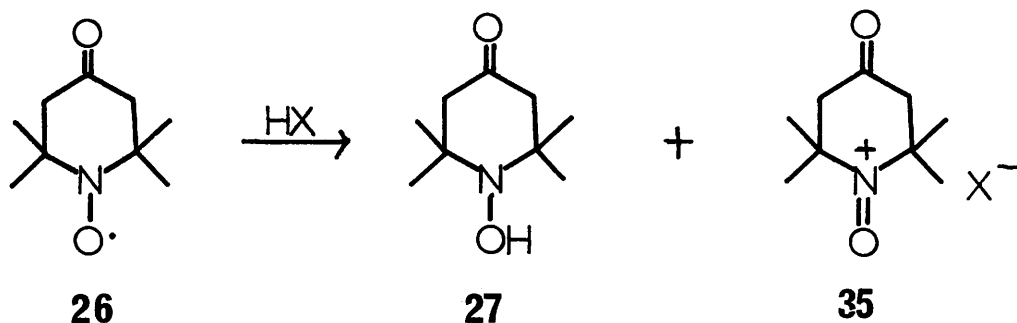

hydroxylamine (27) and the immonium oxide salt (35) which further decomposes to a nitroso compound<sup>45</sup>.

Necessarily this introduction has only scratched the surface of nitroxide radical chemistry. However, it is hoped that this short summary of some aspects of the subject will prepare the ground for a full appreciation of the ensuing discussions. Aspects which have received only scant attention here, such as the important areas of spin-trapping and spin-labelling, will be elaborated upon where necessary in the subsequent sections. The work described is essentially in two parts; the first section

dealing with the development of a general route to some functionalised nitroxides, the second section dealing with the stability of some alkyl-t-butyl nitroxides and related compounds.

M.P. Journal of the Chemical Society

Chemical Communications, 1970, 1570.

C.H. Griffith and A.S. Waggoner, Amer. J. Pharm. Sci., 1968, 66, 100.

C.H. Griffith and A.S. Waggoner, Methods in Biochem. Anal., C. S. Engel, ed., Journal of Pharmacology, Vol. 1, Appleton-Century-Crofts, New York, 1971.

M.J. Perkins, Essays in Free Radical Chem., 5, Chem. Soc. Special Publication

8.9. Jensen, Accounts Chem. Res., 2,

For leading references see:-

I.E. Brownlie and A.U. Ingold, Canad. J. Chem., 45, 2427, 1967.

A.R. Forrester, J.H. Eay and I.H. The Chemistry of Stable Free Radicals, Clarendon Press, 1968.

A.M. Kozlov, Free Radicals in Medical Chemistry, 1977.

A.M. Kozlov and V.M. Lushko, Sov. Chem.

REFERENCES.

1. O. Piloty and B.G. Schwerin, Ber., 34, 1870, 2354, 1901.
2. O.L. Lebedev, and S.M. Kazarnovskii, Papers on Chemistry and Chemical Technology, Gor'kii, 2, 649, 1959.
3. H.M. McConnell and B.G. McFarland, Quart. Revs. Biophysics, 3, 91, 1970.  
O.H. Griffith and A.S. Waggoner, Accounts Chem. Res., 2, 17, 1969.
4. P. Jost and O.H. Griffith, Methods in Pharmacology, Chap. 2, C. Chignell Ed., Physical Methods in Pharmacology, Vol. 2, Appleton-Century-Crofts, New York, 1971.
5. M.J. Perkins, Essays on Free Radical Chemistry, Chap. 5, Chem. Soc. Special Publication No. 24, 1970.  
E.G. Janzen, Accounts Chem. Res., 4, 31, 1971.
6. For leading references see:-  
I.T. Brownlie and K.U. Ingold, Canad. J. Chem., 45, 2427, 1967.
7. A.R. Forrester, J.M. Hay and R.H. Thomson, Organic Chemistry of Stable Free Radicals, Chap. 5, Academic Press, 1968.
8. E.G. Rozantsev, Free Nitroxyl Radicals, Plenum Press, 1970.
9. E.G. Rozantsev and V.D. Sholle, Synthesis, 190, 401, 1971.
10. E.G. Rozantsev, Russ. Chem. Rev., 35, 658, 1966.
11. R. Briere, H. Lemaire and A. Rassat, Bull. Soc. Chim France, 3273, 1965.

11. O. Kikuchi, Bull. Chem. Soc. Japan, 42, 47, 1969.
12. C.L. Hamilton and H.M. McConnell, Structural Chemistry and Molecular Biology, A. Rich and N. Davidson Ed., W. H. Freeman and Co., San Francisco, 115, 1968.
13. T.J. Stone, D. Beckmann, P.L. Nordio and H.M. McConnell, Proc. Nat. Acad. Sci. U.S., 54, 1010, 1965.
14. L. Efskind, Acta Chem. Scand., 27, 71, 1973.
15. B. Andersen and D. Andersen, Acta Chem. Scand., 20, 2728, 1966.
16. C. Glidewell, D.W.H. Rankin, A.G. Robiette, G.M. Sheldrick and S.M. Williamson, J. Chem. Soc. (A), 478, 1971.
17. L.J. Berliner, Acta Cryst., 1326, 1198, 1970.
18. D.M. Hawley, G. Ferguson and J.M. Robertson, J. Chem. Soc. (B), 1225, 1968.
19. J.C.A. Boeyens, and G.J. Kruger, Acta Cryst., B26, 668, 1970.
20. A. Capiomont, B. Chion and J. Lajzerowicz, Acta Cryst., B27, 322, 1971.
21. B. Chion and J. Lajzerowicz, Acta Cryst., B28, 618, 1972.
22. A.W. Hanson, Acta Cryst., 6, 32, 1953.
23. A.W. Salotto and L. Burnelle, J. Chem. Phys., 53, 333, 1970.
24. G.R. Underwood and V.L. Vogel, Mol. Phys., 19, 621, 1970.
25. A. Rassat and P. Rey, Tetrahedron, 29, 1599, 1973.
26. C. Morat and A. Rassat, Tetrahedron, 28, 735, 1972.
27. R. Briere, H. Lemaire and A. Rassat, Tet. L ett., 1775, 1964.

28. I. Morishima, K. Yoshikawa, T. Yonezawa and H. Matsumoto, Chem. Phys. Lett., 16, 336, 1972.
29. D.E. O'Reilly and J.H. Anderson in Physics and Chemistry of the Organic Solid State, M.M. Labes and A. Weissenberger, Ed., Vol.2, 323, Interscience, New York, 1965.
30. A. Mackor, Th. A.J.W. Wajer and Th. J. de Boer, Tetrahedron, 24, 1623, 1968.
31. R.W. Kreilick, J. Chem. Phys., 46, 4260, 1967; ibid., 45, 1922, 1966.
32. R.W. Kreilick, Mol. Phys., 14, 495, 1968.
33. J.L. Duncan, A.R. Forrester, G. McConnachie and P.D. Mallinson, J.C.S. Perk 11, 718, 1973.
34. W.B. Motherwell and J.S. Roberts, Tet. Lett., 4287, 1972.
35. A. Morrison and A.P. Davies, Org. Mass. Spec., 3, 353, 1970.
36. A.R. Forrester and R.H. Thomson, Nature, 202, 74, 1964.
37. K. Adamic, D.F. Bowman, J. Gillan and K.U. Ingold, J. Amer. Chem. Soc., 93, 902, 1971.
38. R.M. Dupeyre and A. Rassat, J. Amer. Chem. Soc., 88, 3180, 1966.
39. W.B. Motherwell and J. S. Roberts, J.C.S. Chem. Comm., 329, 1972.
40. T. Yoshioka, S. Higashida, S. Morimura and K. Murayama, Bull. Chem. Soc. Jap., 44, 2207, 1971.
41. For a review see:-  
D.P. Babb and J.M. Shreeve, Intra-Science Chemistry Reports, 5, 55, 1971.



42. R.E. Banks, D.R. Choudhury and R.N. Haszeldine, J.C.S. Perk I, 1092, 1973, and references cited therein.
43. R.E. Banks, K.C. Eapen, R.N. Haszeldine, P. Mitra, T. Myerscough and S. Smith, J.C.S. Chem. Comm., 833, 1972.
44. J.F.W. Keana, R.J. Dinerstein and F. Baitis, J. Org. Chem., 36, 209, 1971.
45. G.A. Abakumov and V.D. Tikhonov, Izv. Akad. Nauk. SSSR, Khim, 796, 1969.

## SECTION ONE



SECTION I.DISCUSSION.

It is interesting to note that the rapid growth in the study of stable dialkyl nitroxide radicals over the last decade has centred around a relatively limited group of structural types. Of these, 2,2,6,6-tetramethyl-4-oxopiperidine-1-oxyl (1) and the derived 3-carbamoyl-2,2,5,5-

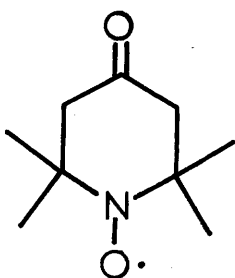
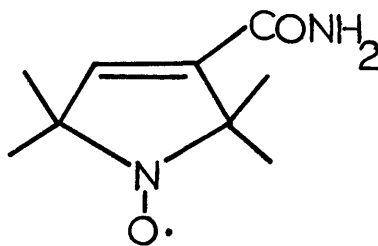
**1****2**

tetramethylpyrroline-1-oxyl (2) have, as a result of subsequent functional group manipulation, been at the focal point of the syntheses of a large number of substituted six- and five-membered cyclic nitroxide radicals respectively.<sup>1,2,3</sup>

This structural type limitation is largely a result of the relative accessibility of the nitroxide (1) and its straightforward conversion into the nitroxide (2). Other structural types (e.g. four- and seven-membered cyclic analogues) are less well-documented by virtue of the rather stringent limits of the presently available synthetic routes to these compounds.

Nevertheless, these readily available structural types have served, in large measure, to assuage the appetites of those

interested in the theoretical and spectroscopic aspects of these remarkable species.

However, in two expanding areas of nitroxide radical application, namely spin-labelling and antioxidant behaviour, the need to establish a wider range of structurally different types is apparent and before presenting the results embodied in this discussion, it is pertinent to summarise briefly these two important applications.

The wide application of nitroxide radicals in spin-labelling is dependent upon three basic factors. First, the shape of the paramagnetic resonance spectrum of a nitroxide (as is generally the case for radicals) is significantly affected by its environment and, in particular, can give information of the degree of rotation of the molecule and on its electrostatic interactions with neighbouring molecules. Secondly, the sensitivity of detection of free radicals by e.p.r. spectroscopy allows very small concentrations of nitroxides to be employed. Thirdly, the relative chemical inertness of nitroxide radicals allows them to be bound to biological systems via an extensive range of functional groups and to be studied under a wide variety of experimental conditions. In biochemical spin-labelling, the nitroxide is attached to a biomolecule thus affording a spin-labelled biomolecule which can then be incorporated into biological systems such as membranes, enzymes or proteins.<sup>4</sup> One such example of the use of biochemical spin-labelling of proteins comes from the elegant work of Griffith and McConnell<sup>5</sup> in which bovine serum albumin (B.S.A.) was labelled with the nitroxide maleimide (3). The e.p.r.

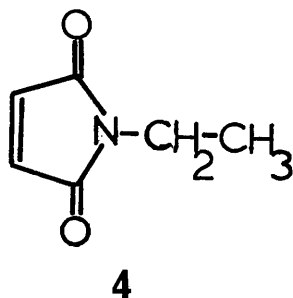
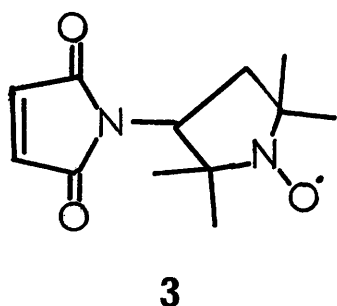

spectrum of the labelled B.S.A. indicated the existence of two types of environment; one in which the nitroxide label was weakly immobilized, the other in which the nitroxide was strongly immobilized. Treatment of the protein with N-ethylmaleimide (4) prior to its reaction with the labelling reagent prevented the appearance of the strongly immobilized portion of the spectrum, so this constrained label was probably attached to a sulphhydryl group. As the pH of the medium was lowered from 4 to 2, B.S.A. underwent a dramatic expansion which was evidenced by the gradual conversion of the strongly immobilized portion of the e.p.r. spectrum into the weakly immobilized signal.<sup>6</sup> This work exemplifies some of the information which can be derived from nitroxide spin-labelling. In general, this technique can yield vital information concerning such aspects as overall conformation of biomolecules, the nature of the environment adjacent to active sites and structural rearrangements resulting from changes in the medium (e.g. pH changes).

Nitroxide radicals have found application in the field of polymer chemistry on two fronts; one in the theoretical study of molecular motions of polymers, the other, as stabilizers against oxidative degradation. In the former

study, the nitroxides are used as 'spin-probes' in a manner akin to their use as spin-labels in biological systems, although in this case the nitroxide is physically added and not covalently bound to the polymer. Consequently, the e.p.r. spectrum of the added nitroxide can be used to correlate the microscopic molecular motions of the polymer chains with the macroscopic behaviour and properties of the polymer particularly at such interesting stages as glass transition points and melting points.<sup>7</sup> The antioxidant properties of nitroxides stem from their radical chain breaking ability. In the auto-oxidation of organic substances, alkyl radicals are produced by the action of alkylperoxy radicals in a chain process as described by equation 1.<sup>8</sup>

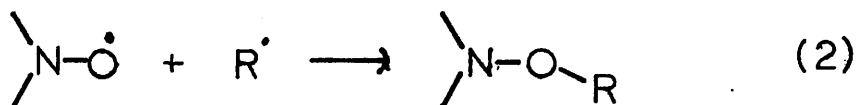

Nitroxide radicals interrupt this chain process by reacting with the alkyl radicals to produce trialkylhydroxylamines (equation 2).<sup>9</sup> The potential use of nitroxides as polymer antioxidants and indeed as antioxidants for monomeric compounds is evidenced by the considerable amount of Patent literature published both in the U.K. and abroad concerning the preparation of functionalised nitroxides.

Having summarized two of the major areas of application of stable nitroxide radicals, the ensuing

discussion can now be placed in context. Before doing so, it is important to emphasise that these areas of application are very much dependent upon there existing a range of nitroxide structures with varying functionality to meet the corresponding diversity of biological and polymeric systems which are encountered. As part of a wider theme of synthesizing nitroxide radicals with sites of unsaturation, it was considered that the diene-nitroxide (5) might find some useful applications.

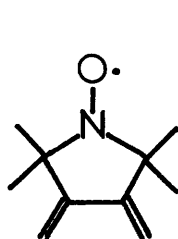

5

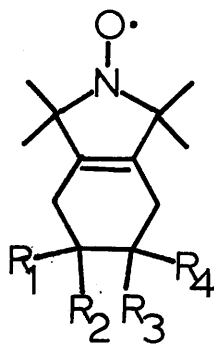

6

In particular, its Diels-Alder adducts (6), obtained from an extensive range of dienophiles, would extend considerably the variety of functionalised nitroxides whose potential as spin-labels and/or antioxidants might be assessed.

The synthetic approach to the diene-nitroxide (5) was relatively straightforward since it simply required conversion of the known amine (7)<sup>10</sup> into

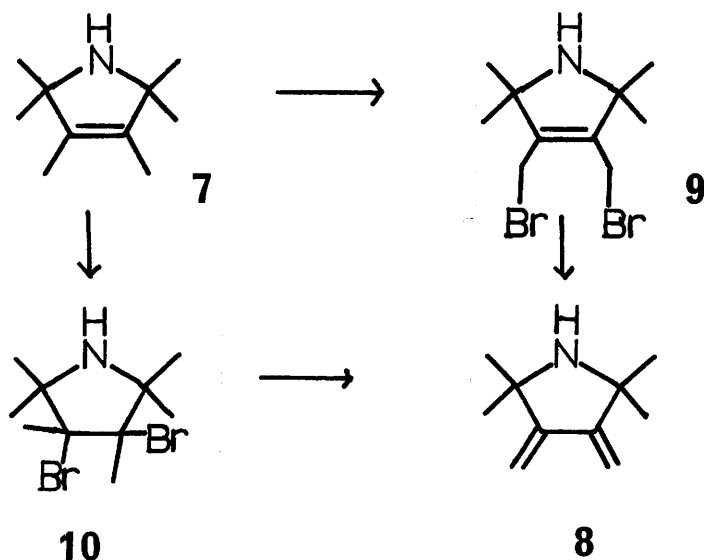

the diene-amine (8) with subsequent oxidation to the nitroxide (5). This conversion was initially tackled by two approaches; (a) by treatment of the amine (7) with N-bromosuccinimide to form the allylic dibromide (9) and subsequent 1,4-debromination to form the diene (8) and (b) by addition of bromine across the double bond of (7) to form the dibromide (10) followed by double dehydrobromination to form the diene (8). The starting compound, 2,2,3,4,5,5-hexamethyl-3-pyrroline (7), was prepared according to Hennion *et. al.*<sup>10</sup> by reduction of bis-(1,1-dimethylpropargyl) amine (11) with sodium in liquid ammonia.



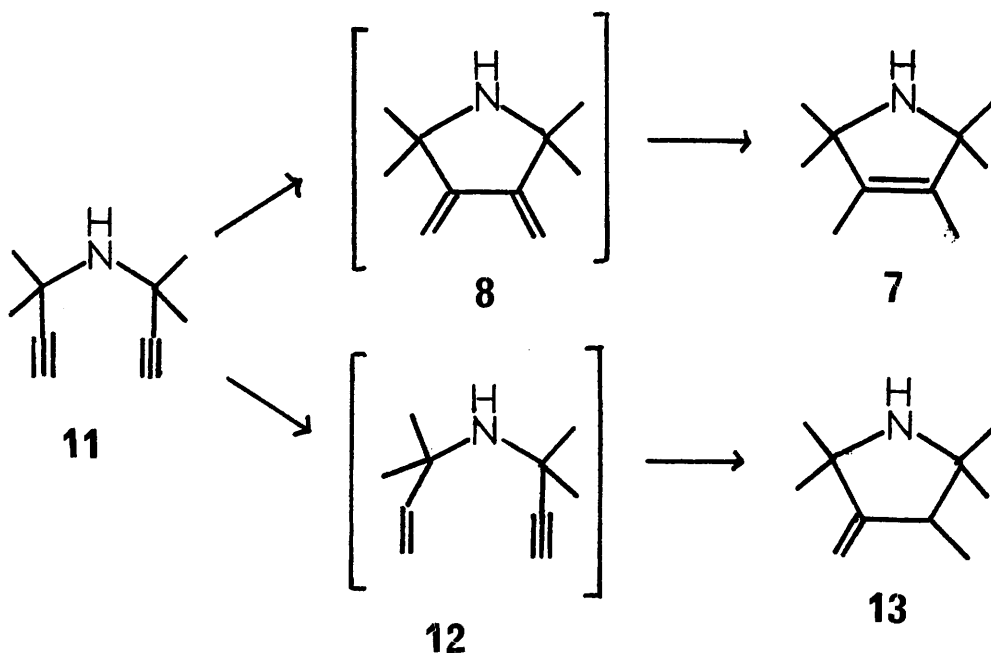

Mechanistically, this somewhat unusual cyclisation is thought to proceed in a manner similar to that suggested by Stork *et al.*<sup>11</sup> for the cyclisation of  $\gamma$ -ethynyl-ketones. While the exact mechanism is subject to speculation, Hennion and Ode<sup>12</sup> favour one which involves reaction of a radical centre (rather than a carbanion<sup>11</sup>) derived from one ethynyl group with the appropriate carbon atom of the other ethynyl group affording the intermediate diene (8) which, under the conditions, would be subject to rapid 1,4-reduction to the amine (7) as outlined below.

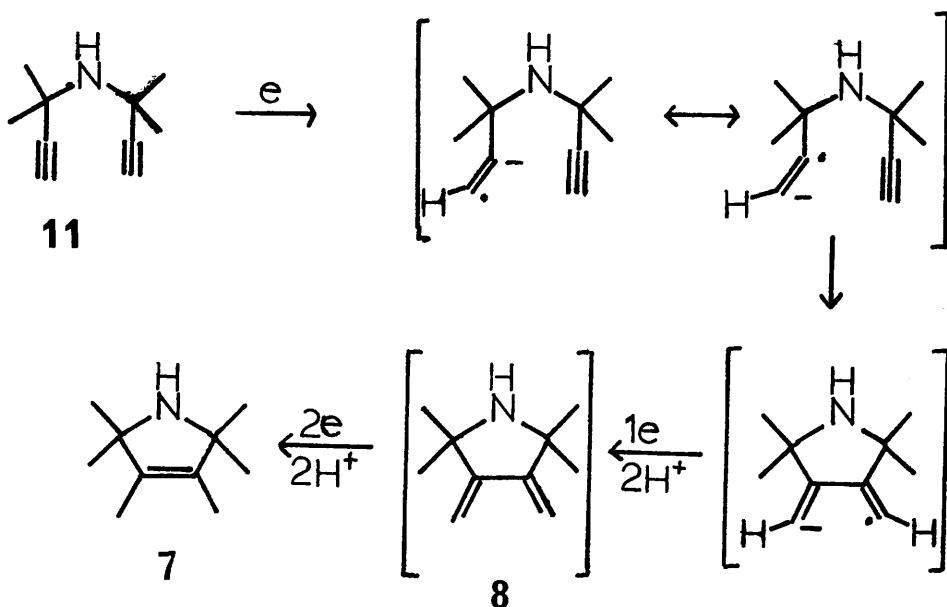

Although Hennion et. al.<sup>10</sup> reported a clean conversion of the bis-acetylenic amine (11) to the cyclic amine (7), in our hands this was not the case and the amine (7) was always contaminated by its isomer, 3-methylene-2,2,4,5,5-pentamethylpyrrolidine (13) (ca. 15% by n.m.r.). This presumably arises via partial reduction of the amine (11) to the olefinic acetylenic amine (12) followed by the known reductive cyclisation<sup>10</sup> to the exomethylene-amine (13). Very recent work in these laboratories<sup>13</sup> has shown that even catalytic hydrogenation of the bis-acetylenic amine (11) over 10% palladium on charcoal results in the formation of the cyclic amines (7), (8) and (13) (total of ca. 35% by g.l.c.) of which the major component is the diene-amine (8). The major product of hydrogenation is, of course, the bis-olefinic amine (14).

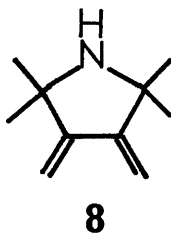
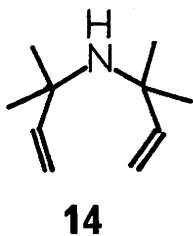

In view of the sterically crowded environment of the amino function, it was decided to attempt the direct allylic bromination of the amine (7) without recourse to an amine protecting group. Thus the amine (7) was reacted with a 2-molar equivalent of N-bromosuccinimide<sup>14</sup> for 20 minutes. This led to a product whose n.m.r. spectrum indicated the formation of a mixture of the N-bromo-amine (15) and the

dibromide (16). Treatment of the amine (7) with a 3-molar

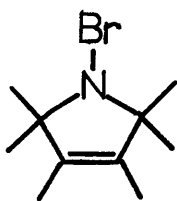

15



16

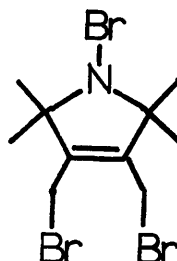

17

equivalent of N-bromosuccinimide for a longer period (2 hours) resulted in the formation of a mixture of the dibromide (16) and the tribromide (17) while after an even longer period (4.5 hours), the product was almost exclusively the tribromide (17). Thus, despite the considerable steric hindrance around the amino moiety, reaction of the amine (7) with N-bromosuccinimide leads, first of all, to the N-bromo-amine (15) subsequently to the dibromide (16) and finally, with sufficient reagent and time, to the tribromide (17). It was obvious therefore that N-bromosuccinimide would be an appropriate reagent for allylic bromination only if the amino function was suitably protected beforehand.

In the alternative approach to the diene-amine (8), the amine (7) was reacted with a solution of bromine in carbon tetrachloride. Although an instantaneous decolouration of the bromine solution occurred, the precipitate which formed was not the expected dibromide (10) but was the hydrobromide

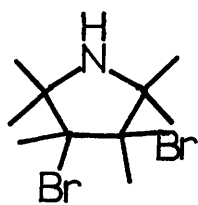

10

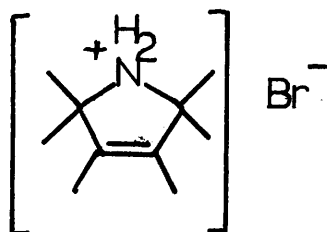

18

salt of the amine (18) as evidenced by its n.m.r. and infra red spectra and by its high water solubility.

Clearly we had totally underestimated the reactivity of the nitrogen atom in these reactions and at this stage it was decided that progress would only be made if the amino function was treated with the respect which it deserved viz. by use of a suitable protecting group. It was considered that a convenient method of protection would be as an amide group. However, we were somewhat concerned as to the possible difficulties of subsequent removal by hydrolysis since it is well known that highly hindered amides can be very resistant to hydrolysis.<sup>15,16</sup> Indeed Ourisson et. al.<sup>17</sup> found that the acetamide (19) was singularly unaffected by treatment at 100°C with 20% hydrochloric acid, 85% phosphoric acid or 10% aqueous sodium hydroxide solutions. Nevertheless, it was decided to protect the

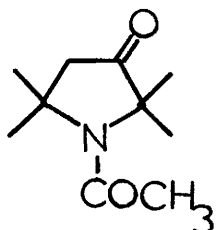

19

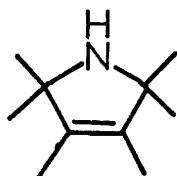

7

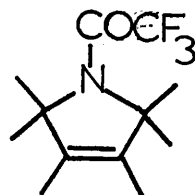

20

amine as its trifluoroacetamide since this grouping, as a result of its ready hydrolysis under mild conditions, has found considerable success as a protecting group for primary amines in the synthesis of peptides.<sup>18</sup> The amine (7) was readily converted into its trifluoroacetamide (20) in high yield by treatment with trifluoroacetic anhydride and pyridine in methylene chloride solution at 0°C. This trifluoroacetamide (20) reacted smoothly and in high yield with N-bromosuccinimide to form the dibromide (21).

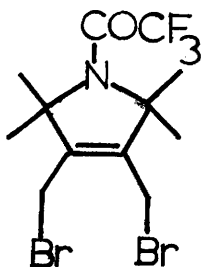

21

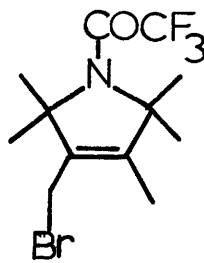

22

If a molar equivalent of N-bromosuccinimide was used, the principal product was the monobromide (22). In theory, both of these bromides could have generated the diene trifluoroacetamide (23), either by metallic 1,4-debromination (e.g. zinc) of the dibromide (21) or by base-induced 1,4-dehydrobromination (e.g. potassium *t*-butoxide) of the monobromide (22). In the event, the former method was chosen because some of the dibromide (21) (ca. 10%) was always produced with the monobromide (22), and since both compounds had virtually identical chromatographic properties, the monobromide (22) was never obtained entirely pure.

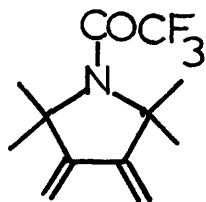

23

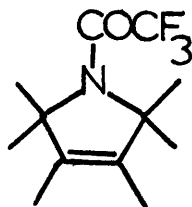

20

Debromination of the dibromide (21) proceeded smoothly in the presence of activated zinc dust in dimethylformamide at 105°C and the diene-trifluoroacetamide (23) was obtained pure as a colourless low-melting solid. The trifluoroacetyl group proved not only to be a suitable amine protecting group during these reactions but as trifluoroacetamides, these compounds were very amenable to chromatographic purification. Now that the trifluoroacetyl group had performed its protecting role, it was necessary to find a suitable means of hydrolysis. In this search, we were, to say the least, somewhat dismayed to find that the hydrolysis of the trifluoroacetamide in no way paralleled its ease of formation and considerable experimentation was required in order to find an efficient method. In studying various hydrolytic methods, the more readily available trifluoroacetamide (20) was used as a model compound. Secondary trifluoroacetamides of glucuronides and glucosides have been readily hydrolysed by room temperature treatment with very mild base e.g. 0.2M NaOH or Ba(OH)<sub>2</sub> solutions,<sup>19</sup> while the trifluoroacetamide ester (24) can be hydrolysed to the amino-acid (25) with 0.1M

tetraethylammonium hydroxide solution.<sup>20</sup> While it is

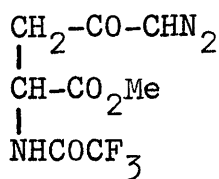

(24)

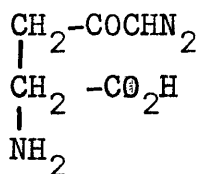

(25)

probable that the effect of substituents on the rate of hydrolysis of secondary amides may not be exactly the same as in the case of tertiary amides, it was felt that with respect to the amide (20), the trifluoroacetyl group might render the carbonyl group sufficiently electrophilic to facilitate hydrolysis under mildly basic conditions. Indeed it has generally been found that the rate of basic hydrolysis of tertiary amides is mildly accelerated by lowering the electron density at the carbonyl carbon atom although retarded by bulky groups.<sup>15</sup> However, the trifluoroacetamide (20) was totally unaffected by treatment with either 7% aqueous methanolic potassium carbonate solution or saturated aqueous barium hydroxide solution. Similarly it was largely unaffected by treatment with methanolic potassium hydroxide solution even after refluxing for 16 hours. It was thereby apparent that the mildly basic hydrolytic conditions used successfully in the peptide field would find no application here and that relatively severer conditions were required. Hence the amide (20) was subjected to treatment with potassium hydroxide in refluxing ethylene glycol for 6.5 hours and although the product included significant amounts of polar material (presumably amine) as observed by t.l.c., this was not a particularly suitable method of hydrolysis for two major

reasons. First, the work-up procedure involved removal of the ethylene glycol as an aqueous phase in which the amine would be partially soluble. Secondly hydrolysis of the diene-trifluoroacetamide (23) under these conditions might possibly promote decomposition of the diene-amine (8) as a result of polymerisation or dimerization.

Somewhat surprisingly, the use of alkylating reagents in amide hydrolysis has not been widespread despite the fact that they appear to afford a smooth means of hydrolysis under relatively mild conditions.<sup>21</sup> For instance the N-benzoyl group in (26) was smoothly removed first by alkylation with

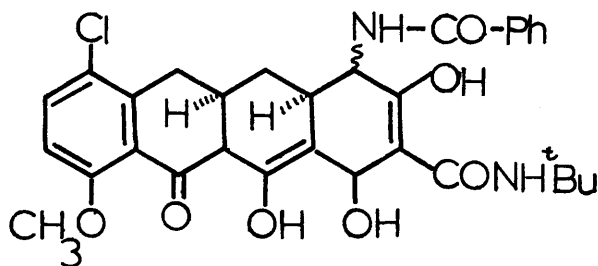

26

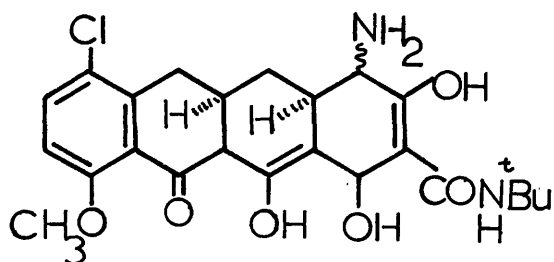

27

Meerwein's reagent (triethyloxonium tetrafluoroborate) followed by treatment in dioxane solution with 3% acetic acid in water to yield the epimers (27).<sup>22</sup> The mechanism involves an initial kinetically-controlled O-alkylation of the amide (thermodynamically-controlled alkylation of carbamates with methyl fluorosulphonate occurs on nitrogen<sup>23</sup>) to form an imino-ether salt (28) as depicted in Scheme 1.



## Scheme 1

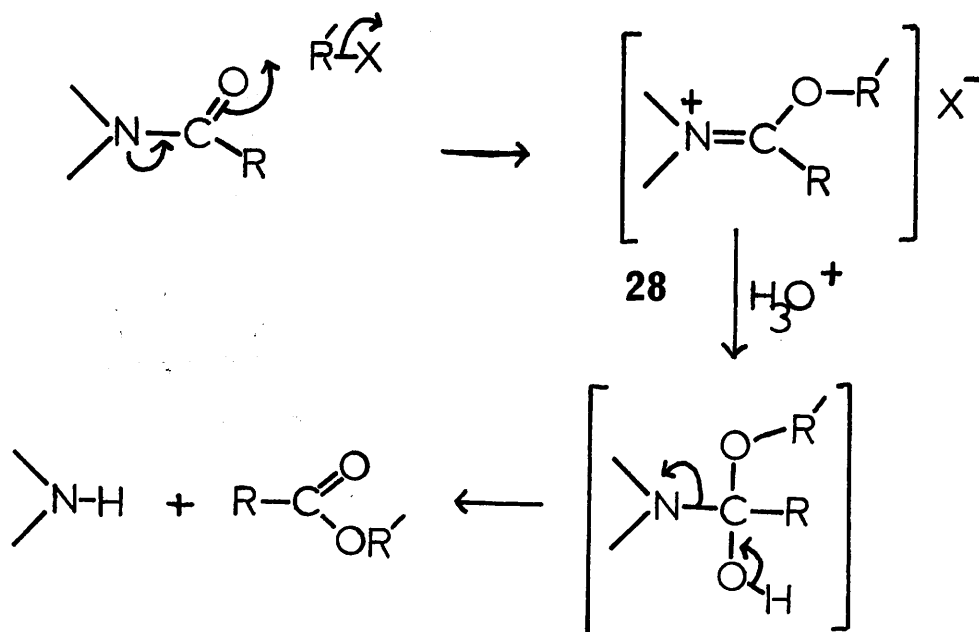

This species (28) can be subsequently hydrolysed with mild aqueous acid to amino and ester fragments. A convenient and reactive methylating reagent is methyl fluorosulphonate<sup>24</sup> ('magic methyl') which is effective for the methylation of amines, amides, nitriles, ethers and sulphides. Alkylation with this reagent can be expediently followed by <sup>1</sup>H or <sup>19</sup>F n.m.r. In this case however, n.m.r. (<sup>1</sup>H and <sup>19</sup>F) monitoring of a solution of the trifluoroacetamide (20) with methyl fluorosulphonate in deuteriochloroform indicated that, even after 3 days, no significant methylation had occurred. One possible explanation of this is that the electrophilic trifluoromethyl group reduces the polarity of the carbonyl group thereby decreasing the electron density on oxygen. This effect is observed in trifluoromethyl ketones such as hexafluoroacetone in which the carbonyl group is more 'covalent' than in acetone i.e. there is less contribution

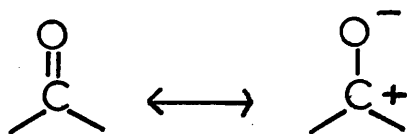

29

from the ionic form in (29). This is manifest by a lower dipole moment and a higher carbonyl stretching frequency (c.a.  $1815\text{cm.}^{-1}$ ) in hexafluoroacetone as compared to acetone.<sup>25</sup> A successful conclusion to these studies was reached when the trifluoroacetamide (20) underwent hydrolysis with potassium *t*-butoxide in tetrahydrofuran at  $0^\circ\text{C}$  for 30 minutes. The polar product of this hydrolysis was positively identified as the amine (7) first, by making a picrate derivative and comparing its melting point with that of the authentic picrate and secondly, by oxidation to the corresponding nitroxide and comparing its t.l.c. characteristics with those of the authentic nitroxide. In terms of the standard mechanism proposed for the basic hydrolysis of amides<sup>15</sup> as outlined below, it is

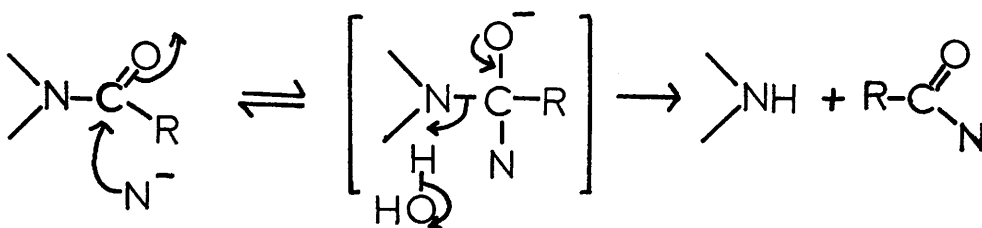

30

difficult to rationalise the relative success of the bulky *t*-butoxide anion over hydroxide in forming the tetrahedral

intermediate (30) particularly in view of the sterically hindered nature of the amide carbonyl group. These results would appear to indicate that the basicity rather than the nucleophilicity of the anion is the feature of paramount importance. In this respect, the recent results of Marshall *et. al.*<sup>26</sup> on the hydrolysis of  $\alpha$ -diketone monothioketals (31) are of interest. These workers found that in the alkoxide-induced cleavage of these compounds, the products were not the expected thioketal carboxylic

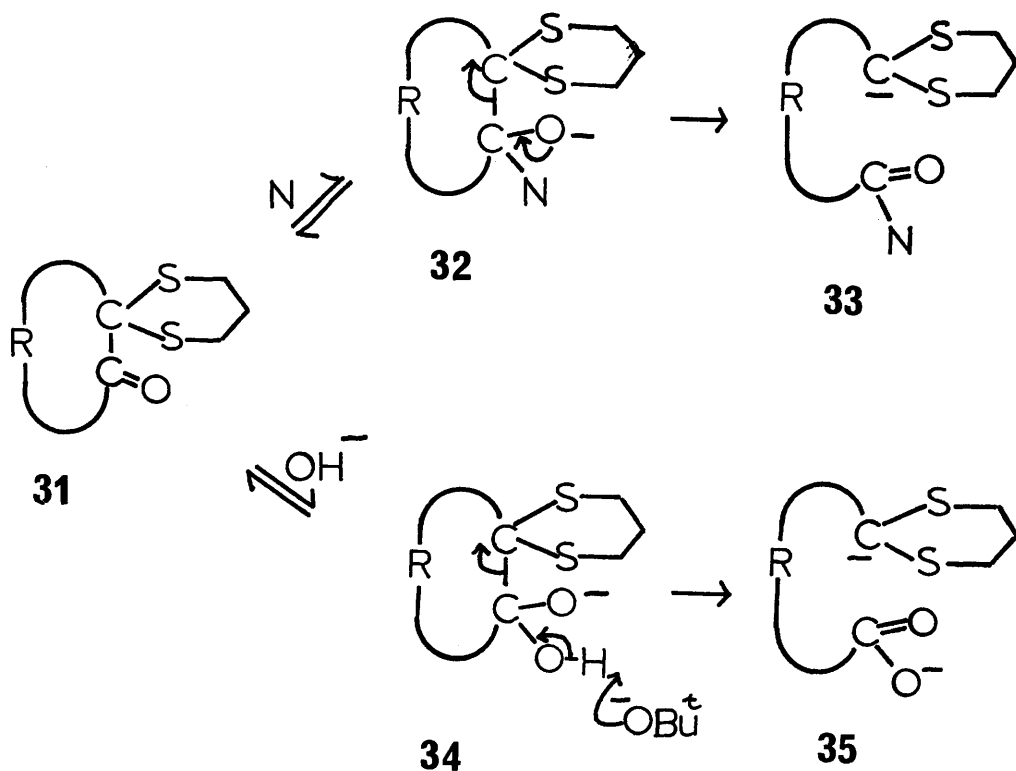

esters (33) but the corresponding acids (35) thereby suggesting that, despite attempts to maintain anhydrous conditions, some water had been present. Further studies showed that water was an essential ingredient in the reaction and indeed, rigorous exclusion of moisture

caused a decrease in the yield of (35). These results prompted the authors to propose a mechanism involving initial attack by hydroxide ion generating the intermediate (34) which, by the action of strong base (e.g. butoxide) underwent conversion to the product (35). With respect to the trifluoroacetamide hydrolysis, this hydroxide-induced mechanism (as outlined below) would appear to offer a much more satisfactory

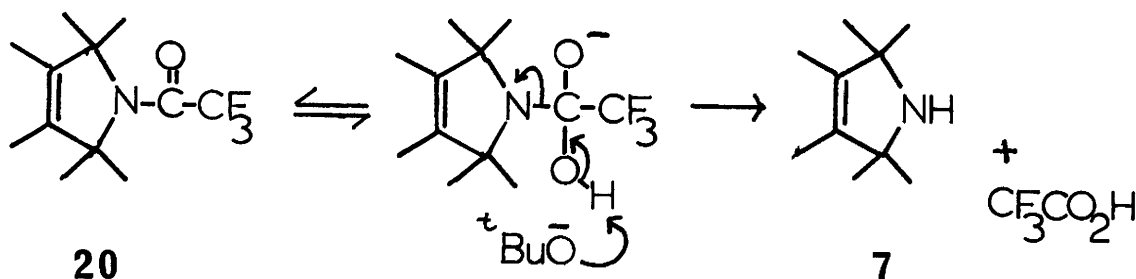

explanation of the relative success of butoxide over hydroxide in effecting hydrolysis since it requires the alkoxide ion to act as a strong base rather than as a good nucleophile. Moreover, it is probable that, despite efforts to the contrary, sufficient moisture is provided by the glass vessels and the atmosphere to allow such a pathway to occur. Similar hydrolysis conditions proved effective in converting the trifluoroacetamide diene (23) into the diene-amine (8) which was obtained as a colourless liquid.

Oxidation of the amine (8) by one of the two standard methods<sup>1,2</sup> afforded the diene-nitroxide (5) i.e. by the

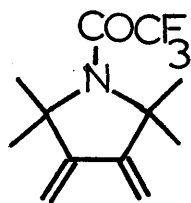

23

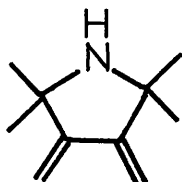

8

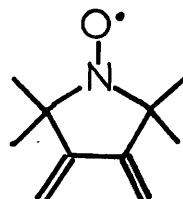

5

action of either m-chloroperbenzoic acid in methylene chloride solution at 0°C for 2 hours or sodium tungstate/hydrogen peroxide in aqueous methanol for about 2 days. Of the two methods, the former proved to be the more convenient. The nitroxide (5) was obtained as yellow/orange needles, m.p. 92-94°C, which proved to be quite stable in air at ambient temperatures. Refluxing a solution of the nitroxide in toluene resulted in only minor decomposition over a period of 17 hours (see section II, Chapter 1). As a check for the possible reaction of the diene function during oxidation of the amine (8), the n.m.r. spectrum of the nitroxide (5) was run in the presence of an equimolar amount of hydrazobenzene. In this technique, the nitroxide radical abstracts the labile hydrogen atoms of hydrazobenzene forming azobenzene and the hydroxylamine whose n.m.r. is noted. Clearly, in the case of dialkyl nitroxides, the azobenzene formed does not complicate the useful region of the n.m.r. spectrum. The presence of the singlets at  $\tau=5.08$  (2H) and 4.52(2H) indicated that the diene function had been unaffected during oxidation of the amine to the nitroxide. The mass spectrum of this

nitroxide did not exhibit an  $M^+$  ion nor even the  $(M+1)^+$  ion characteristic of most nitroxides. The highest peak (also the base peak) was an  $(M-30)^+$  peak corresponding to the fragment (36) formed by loss of nitric oxide.

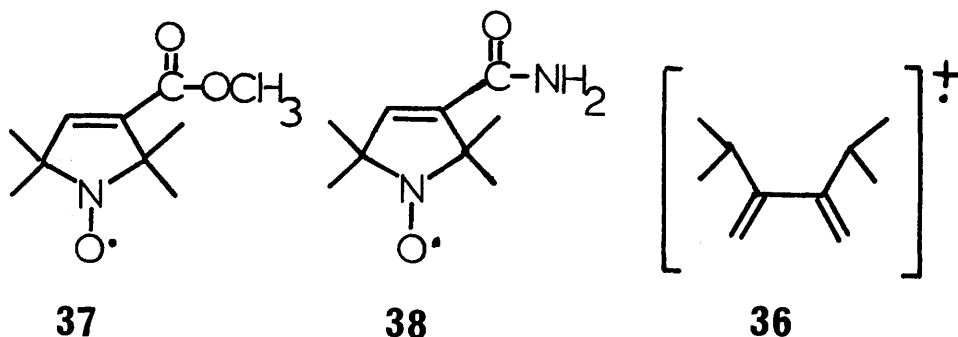

Similar behaviour has been observed in the mass spectra of the nitroxides (37) and (38).<sup>27</sup>

The u.v. spectra of the dienes in this series deserve some comment. Listed below are the wavelengths and corresponding  $\epsilon$  values of the diene chromophore in the three respective compounds. Apparently the nature of the substituent on

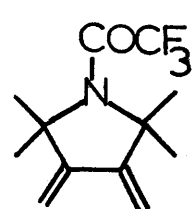
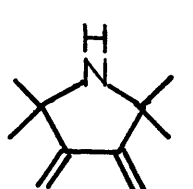
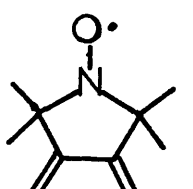
			$\lambda_{\text{max. nm}}$	$\epsilon$
23		(hexane)	240	6,040
8		(petroleum ether)	244	5,960
5		(hexane)	237	5,200

nitrogen does not alter greatly the intensity or wavelength of the diene absorption ; all three compounds have absorbances with  $\lambda_{\text{max.}}$  values of ca. 240 nm. and  $\epsilon$  values of ca. 5000-6000. Ring conformation of exocyclic dienes is known to have a pronounced effect upon the characteristics of the diene u.v. absorption. For example, a comparison of the u.v. spectra of 1,2-dimethylenecyclohexane (39) and 1,2-dimethylenecyclopentane (40) shows that (relative to the cyclopentane ring) the conformation of the

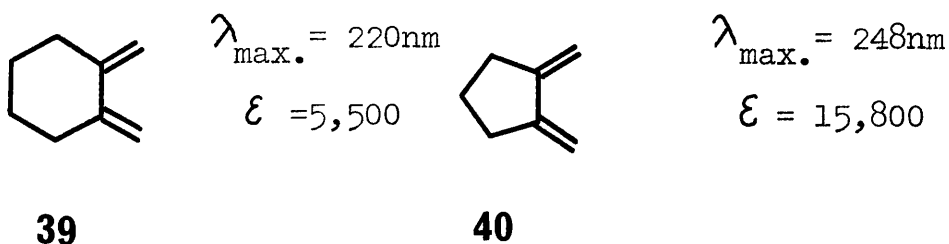

cyclohexane ring forces the dihedral angle between the double bonds to increase thus reducing the orbital overlap between them. This results in the diene absorption in (39) occurring at shorter wavelength with reduced intensity compared to (40). The effect of hetero-atom substituents on the diene absorption is more difficult to assess. In a related area however, Sandris and Ourisson<sup>28</sup> have shown that for a series of hetero-substituted cyclopentane-1,2-diones (41), the diketone absorption is very much

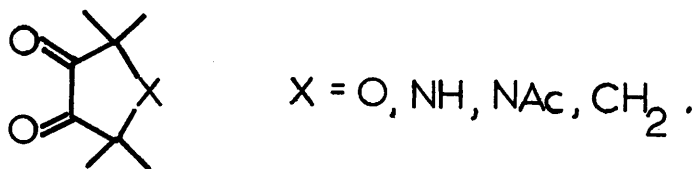
**41**

dependent upon the nature of the hetero-atom, and varies in an order which reflects the degree of polarisation of the C-X bonds. In comparing 1,2-dimethylenecyclopentane (40) with 3,4-dimethylenefuran (43)<sup>29</sup>, 3,4-dimethylenepyrrolidine (42)<sup>30</sup> and 3,4-dimethylenethiolan (44)<sup>30</sup>, the one significant point which emerges is that substitution of a hetero-atom into the carbocyclic ring results in a marked decrease in the intensity of the diene absorption. More

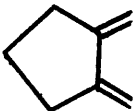
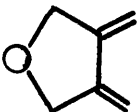
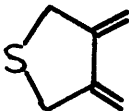
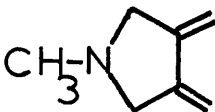
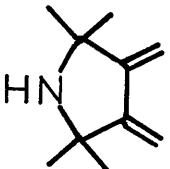
		$\lambda_{\text{max.}}$ nm	$\epsilon$
	<b>40</b>	248	15,800
	<b>43</b>	244	9,820
	<b>44</b>	240	6,000
	<b>42</b>	240 (sh)	8,300
		245	8,700
	<b>8</b>	244	5,960

specifically, in comparing the absorbance values for the amine (8) with those of 3,4-dimethylenepyrrolidine (42), one is led inescapably to the conclusion that the presence of the gem-dimethyl groups in (8)



causes a significant reduction in the intensity of the diene absorption at ca. 245nm. One possible explanation of this is that steric interactions between the gem-dimethyl groups causes some puckering of the cyclopentane ring thus forcing the double bonds out of a cis-coplanar relationship with consequent reduction in overlap. This possibility is borne out by an examination of molecular models.

Fortunately however, any such possible skewing of the diene moiety did not seriously impair the ability of the dienes to undergo Diels-Alder reactions. Thus the diene-trifluoroacetamide (23) readily underwent cycloaddition at room temperature with the dienophiles maleic anhydride, dimethyl acetylene dicarboxylate and tetracyanoethylene to afford the crystalline adducts (45), (46) and (47) respectively.

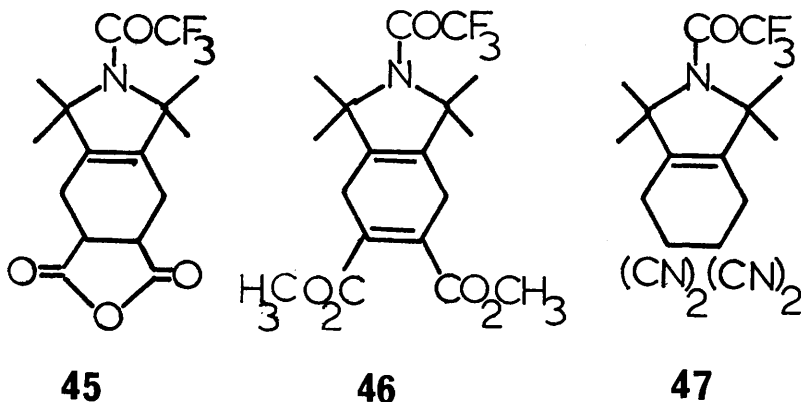

What was synthetically more rewarding was the fact that the diene-nitroxide (5) itself was also a relatively reactive diene forming the crystalline adducts (48), (49) and (50) with maleic anhydride, dimethyl acetylene dicarboxylate and diethyl azodicarboxylate respectively.

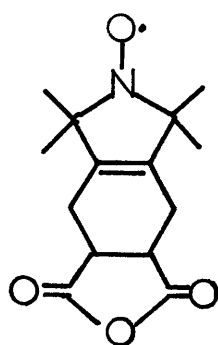

48

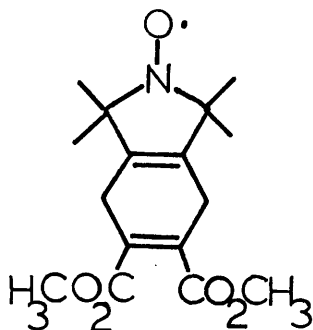

49

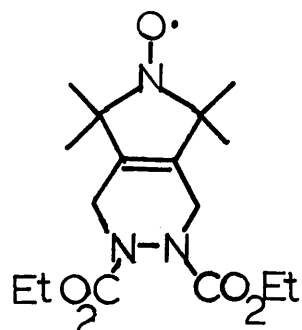

50

All the aforementioned adducts were formed in high yields by allowing equimolar quantities of the diene and dienophile to stand at room temperature for a number of days. Only in the case of tetracyanoethylene was there any reaction involving loss of the nitroxide moiety. Thus mixing equimolar amounts of the diene-nitroxide and tetracyanoethylene resulted in an instantaneous reaction with an attendant intense colouration. Although no identifiable products were obtained, it was clear that some kind of radical reaction of the nitroxide moiety with tetracyanoethylene had taken place. This is not altogether surprising since tetracyanoethylene reacts readily with radicals and, as a result of its high electron affinity, readily undergoes one electron reduction to form its intensely coloured radical anion.<sup>31</sup> Either or both of these factors could account for the loss of the nitroxide function in this reaction. The reaction of the diene-nitroxide (5) with diethyl azodicarboxylate was found to be very sluggish until a few drops of trifluoroacetic acid were added. It is well known that the Diels-Alder

addition of diethyl azodicarboxylate are catalysed by acids and even acidic solvents.<sup>32</sup> Moreover, the rates of addition are influenced by u.v. light and since u.v. light is believed to first effect isomerization of a trans-azo compound to its cis-form,<sup>33</sup> the catalytic effect of acids and u.v. light probably results from isomerization of the trans-azo compound to its more reactive cis-form as outlined below.

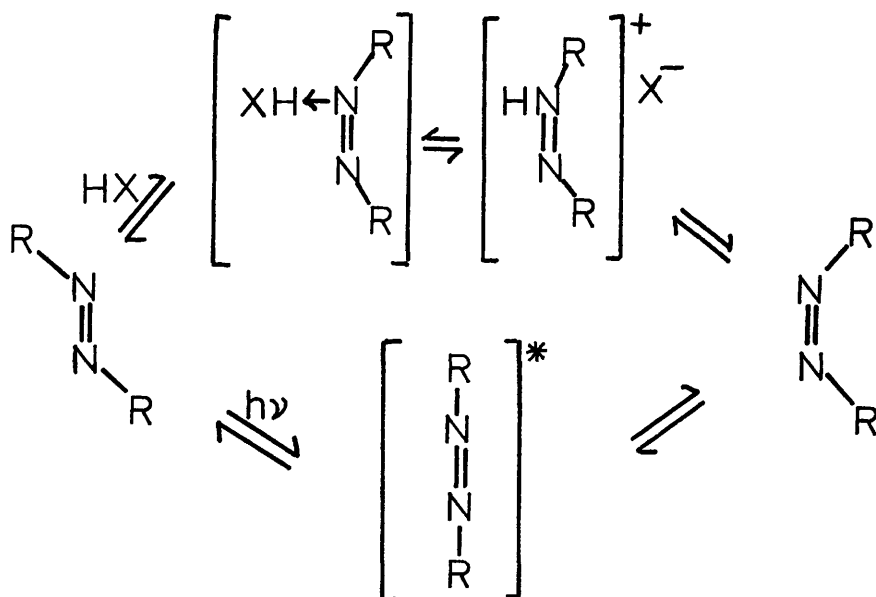

Clearly these experiments have demonstrated that the synthesis of the diene-nitroxide (5) has opened up a potential route to a wide range of nitroxides of differing functionality which, besides being of general interest, may find particular application as antioxidants, biochemical spin-labels or spin-probes. Moreover, the Diels-Alder adducts of the amine (8) could give rise to a wide range of 'blocked amines' which would be of pharmacological interest as a result of their potential M.A.O. inhibition and anti-hypertensive properties.<sup>34</sup> However, further work would be required to determine the range of dienophiles

with which the dienes (5) and (8) can undergo cyclo-addition with particular reference to the degree of activation required in the dienophile before the full potential of these compounds could be realised.

EXPERIMENTAL PROCEDURE

Melting points were recorded on a Kofler hot-stage and are uncorrected ; boiling points are not corrected.

Infrared spectra were recorded on Perkin-Elmer 720 and 157G instruments. Ultraviolet spectra were recorded on a Unicam SP 8000 instrument. Nuclear magnetic resonance spectra were recorded on Varian T 60, Varian HA-100 or Perkin-Elmer R 10 spectrometers using tetramethylsilane as internal standard. Electron paramagnetic resonance spectra were recorded on a Jeol JES-PELX spectrometer operating in the X-band region at a frequency of 9400 MHz (with benzene as solvent unless otherwise stated). Mass spectra were recorded on AEI MS12 and MS9 instruments.

Gas liquid chromatography was performed on Perkin-Elmer F11 instruments using metal columns and nitrogen as the carrier gas. Thin and thick layer chromatography was carried out using Kieselgel silica while column chromatography was carried out with Woelm alumina.

Kinetic data was obtained on a Gilford 2400-S spectrophotometer linked to an automatic chart recorder.

EXPERIMENTAL.2,2,3,4,5,5-hexamethyl-3-pyrroline (7).

This was prepared by the reduction of bis (1,1-dimethylpropargyl) amine (11) with sodium in liquid ammonia according to Hennion and DiGiovanna<sup>10</sup> and was obtained as a clear liquid, b.p. 50-55°C/15mm., lit., 64-70°C/20mm.  $\gamma$ (CDCl<sub>3</sub>) = 8.85 (12H, singlet), (CH<sub>3</sub>)<sub>2</sub>-C-N, 8.45 (6H, singlet), CH<sub>3</sub>-C=C.

Reaction of 2,2,3,4,5,5-hexamethyl-3-pyrroline (7) with N-bromosuccinimide.

This reaction generally gave mixtures of products which were extremely difficult to separate. However, the ensuing experimental evidence serves to indicate the sequence of reaction events and thus explains the ultimate need for a nitrogen protecting group in this reaction.

1. Two molar ratio of N-bromosuccinimide to amine (7).

To a solution of 2,2,3,4,5,5-hexamethyl-3-pyrroline (7) (100mg.) in carbon tetrachloride (2ml.) was added N-bromosuccinimide\* (256mg.) and dibenzoyl peroxide (4mg.). The resultant heterogeneous solution was refluxed for 20 minutes. After this time, most of the N-bromosuccinimide had reacted leaving the less dense succinimide floating on the liquid surface. Filtration and subsequent removal

\* Crude, amorphous N-bromosuccinimide was preferred since it contains impurities which promote initiation of the bromination.

of solvent under reduced pressure yielded a yellow oil. Preparative t.l.c. (30% ether/60-80 petroleum ether) allowed partial purification to a yellow, semi-crystalline oil (81 mg.) whose n.m.r. and i.r. spectra were consistent with a mixture of 1-bromo-2,2,3,4,5,5-hexamethyl-3-pyrroline (15) and 1-bromo-3-bromomethyl-2,2,4,5,5-pentamethyl-3-pyrroline (16).

2. Three molar ratio of N-bromosuccinimide to amine (7).

(a). To a solution of the amine (7) (100mg.) in carbon tetrachloride (3ml.) was added N-bromosuccinimide (384 mg.) and dibenzoyl peroxide (6mg.). The resultant heterogeneous solution was refluxed for 2 hours. Filtration followed by removal of solvent under reduced pressure yielded a yellow oil (236mg.). Preparative t.l.c. (chloroform) yielded a yellow oil (65mg.) whose n.m.r. spectrum was consistent with a mixture of 1-bromo-3-bromomethyl-2,2,4,5,5-pentamethyl-3-pyrroline (16) and 1-bromo-3,4-di (bromomethyl)-2,2,5,5-tetramethyl-3-pyrroline (17).

(b). The same heterogeneous <sup>solution</sup> as in the previous case (a) was refluxed, this time, for 4.5 hours. After this time only a small amount of the more dense N-bromosuccinimide remained. Filtration followed by removal of solvent under reduced pressure yielded a yellow oil (279mg.) which was partially purified by preparative t.l.c. (chloroform) giving a yellow oil (51mg.). The n.m.r. spectrum indicated that this material, whilst being impure, was largely 1-bromo-3,4-di(bromomethyl)-2,2,5,5-tetramethyl-3-pyrroline (17).

$\tau(\text{CDCl}_3) = 8.65$  (12H, singlet),  $(\text{CH}_3)_2\text{-C-N}$ , 5.95 (4H, singlet),  $\text{Br-CH}_2\text{-C=C}$ .

Reaction of 2,2,3,4,5,5-hexamethyl-3-pyrroline (7) with bromine.

To a solution of the amine (7) (100mg.) in carbon tetrachloride (2ml.) was added dropwise, with stirring at room temperature, a solution of bromine (110mg) in carbon tetrachloride (3ml.). There was an instantaneous decolouration of the solution accompanied by the formation of a precipitate. After complete addition of the bromine solution, the precipitate was filtered off and washed with carbon tetrachloride to yield yellow coloured crystals (109mg.). N.m.r. and i.r. data were consistent with this compound being the hydrobromide salt of 2,2,3,4,5,5-hexamethyl-3-pyrroline (18).

$\tau(\text{CDCl}_3) = 8.36$  (6H, singlet),  $\text{CH}_2\text{-C=C}$ , 8.27 (12H, singlet),  $(\text{CH}_3)_2\text{-C-N}$ .

$\nu_{\text{max.}}$  (Nujol) = 2800-2400 (series of low intensity peaks), 1580, 1460, 1380 and 1290 $\text{cm.}^{-1}$ .

1-Trifluoroacetyl-2,2,3,4,5,5-hexamethyl-3-pyrroline (20).

A solution of 2,2,3,4,5,5-hexamethyl-3-pyrroline (7) (15gm.) in dry pyridine (18gm.) and dry methylene chloride (300ml.) was cooled to 0°C in an ice bath. To this cooled solution was added dropwise, with stirring, over a period of 1.25 hours, a solution of trifluoroacetic anhydride (69ml.) in dry methylene chloride (150ml.). The solution was stirred for a further 3 hours during which time it was allowed to reach room temperature and was subsequently left standing overnight. To this



solution crushed ice (150gm.) was added with stirring followed by methylene chloride (200ml.) and water (100ml.). After separation from the aqueous phase the organic extract was washed with dilute hydrochloric acid solution (1M, 100ml.) followed by saturated brine solution (100ml.) and subsequently dried over anhydrous potassium carbonate. The solvent was removed under reduced pressure to yield a dark-coloured oil (24.4 gm.). This material was used without further purification in the next stage.

Purification could be effected either by preparative t.l.c. (20% ether/60-80 petroleum ether) or by column chromatography on Grade 111 neutral alumina eluting with 10% ether/40-60 petroleum ether yielding a colourless, low melting, solid, m.p. 20°C.

$\nu_{\text{max.}}$  ( $\text{CCl}_4$ ) = 1665, 1210, 1165, 1145 and 1050  $\text{cm}^{-1}$   
 $\tau(\text{CDCl}_3)$  = 8.48 (12H, singlet),  $(\text{CH}_2)_2\text{-C-N}$ , 8.37 (6H, singlet),  $\text{CH}_2\text{-C=C}$ .

$M^+$  = 249 (very weak), large fragmentation at  $M^+-15 = 234$

Analysis ; Found : C 57.53; H, 7.01; N, 5.75%.

$\text{C}_{12}\text{H}_{18}\text{NOF}_3$  Requires: C, 57.81; H, 7.28; N, 5.62%.

1-Trifluoroacetyl-3,4-di(bromomethyl)-2,2,5,5-tetramethyl-3-pyrroline (21).

To a solution of the crude amide (20) (15gm.) in dry carbon tetrachloride (700ml.) was added N-bromosuccinimide (30.6gm.) and dibenzoyl peroxide (0.72gm.). The resultant heterogeneous solution was refluxed for 40 minutes. The less dense succinimide was removed by filtration and the solvent removed under reduced pressure to yield a semi-crystalline brown oil (27.4gm.). This

material was used without further purification in the next stage.

Purification could be effected either by column chromatography on Grade III neutral alumina eluting with 10% ether/40-60 petroleum ether or by preparative t.l.c. (20% ether/60-80 petroleum ether) yielding colourless crystals, m.p. 42-44°C.

$\nu_{\text{max.}}$  (CCl<sub>4</sub>) = 1670, 1375, 1210, 1160, 1145, 1050, 890, 650 and 580 cm.<sup>-1</sup>.

$\tau$ (CDCl<sub>3</sub>) = 8.35 (12H, singlet), (CH<sub>3</sub>)<sub>2</sub>-C-N, 5.95 (4H, singlet), Br-CH<sub>2</sub>-C=C.

M<sup>+</sup>, not observed, strong M<sup>+</sup>-15 = 392 (2Br isotope pattern)

Analysis : Found : C, 35.22; H, 4.14; N, 3.53%.

C<sub>12</sub>H<sub>16</sub>NOBr<sub>2</sub>F<sub>3</sub>; Requires : C, 35.40; H, 3.96; N, 3.44%.

1-Trifluoroacetyl-3-bromomethyl-2,2,4,5,5-pentamethyl-3-pyrroline (22).

To a solution of the crude amide (20) (500mg.) in carbon tetrachloride (24ml.) was added N-bromosuccinimide (392mg.) and dibenzoyl peroxide (9mg.). The resultant heterogeneous solution was refluxed for 40 minutes. The less dense succinimide was removed by filtration and the solvent removed under reduced pressure to yield a semi-crystalline oil (667mg.). Preparative t.l.c. (20% ether/60-80 petroleum ether) yielded a colourless oil (447mg.) whose n.m.r. spectrum was largely consistent with the structure of the title compound (22).

$\tau$ (CDCl<sub>3</sub>) = 8.48 (6H, singlet), (CH<sub>3</sub>)<sub>2</sub>-C-N, 8.39 (6H, singlet), (CH<sub>3</sub>)<sub>2</sub>-C-N, 8.24 (3H, singlet), CH<sub>3</sub>-C=C, 6.04 (2H, singlet), Br-CH<sub>2</sub>-C=C.

A relatively small peak (ca. 10% impurity) at  $\tau = 5.90$  indicated the presence of some dibromo compound (21). simultaneous t.l.c. (20% ether/60-80 petroleum ether) of the mono- and dibromo-amides showed that they had such similar  $R_f$  values as to render their separation by this method virtually impossible.

1-Trifluoroacetyl-3,4-dimethylene-2,2,5,5-tetramethyl-pyrrolidine (23).

Activated zinc dust\* (18gm.) was added to a solution of the crude dibromide (21) (27.4gm.) in dry dimethylformamide (500 ml.). The resultant heterogeneous solution was stirred vigorously at  $105^\circ$  for 2 hours (reflux condenser fitted). After cooling, water (400ml.) and ether (400ml.) were added, the insoluble inorganic material removed by filtration and the filtrate was shaken vigorously in a separating funnel. The aqueous layer was run off and extracted with ether (2 x 200ml.). The combined ethereal extracts were dried over anhydrous potassium carbonate and the solvent removed under reduced pressure to yield a dark-coloured oil. This material was purified by column chromatography (Grade III neutral alumina (150gm.)), eluting with 10% ether/40-60 petroleum ether. The diene (23) (8.62gm.) was collected in one fraction after removal of the solvent under reduced pressure. This material was used without further purification in the next stage.

\* The zinc dust was activated by sequential washing with dilute hydrochloric acid (5%), water, methanol, and ether and then finally dried.

Further purification could be achieved by preparative t.l.c. (20% ether/60-80 petroleum ether) to yield colourless crystals, m.p. 39-41°C.

$\nu_{\text{max.}}$  ( $\text{CCl}_4$ ) = 1670, 1415, 1215, 1150, 1050 and 895  $\text{cm}^{-1}$   
 $\tau$  ( $\text{CDCl}_3$ ) = 8.39 (12H, singlet),  $(\text{CH}_3)_2\text{-C-N}$ , 5.02 (2H, singlet),  $\text{CH}_2=\text{C-}$ , 4.47 (2H, singlet),  $\text{CH}_2=\text{C-}$ .

$\lambda_{\text{max.}}$  (hexane) = 240nm. ( $\epsilon=6040$ ).

$M^+$  = 247 (weak), large fragment ion at  $M^+-15=232$ .

Analysis; Found : C, 58.23; H, 6.39; N, 5.55%.

$\text{C}_{12}\text{H}_{16}\text{NOF}_3$  Requires : C, 58.28; H, 6.52; N, 5.66%.

### Hydrolysis of 1-trifluoroacetyl-2,2,3,4,5,5-hexamethyl-3-pyrroline (20).

The following reactions were performed with a view to obtaining an efficient method of hydrolysis under the mildest possible conditions.

#### 1). Aqueous potassium carbonate solution.

A solution of potassium carbonate (7% in aqueous methanol, 5 ml.) was added to the amide (20) (50mg.) and the resultant solution stirred at room temperature for 12 hours. Subsequent t.l.c. analysis (20% ether/60-80 petroleum ether) indicated no reaction.

#### 2). Saturated barium hydroxide solution

A saturated solution of barium hydroxide (3ml.) was added to a solution of the amide (20) (50mg.) in methanol (2ml.) and the resultant solution stirred at room temperature for 24 hours. Subsequent t.l.c. analysis (20% ether/60-80 petroleum ether) indicated no reaction.

3). Methanolic potassium hydroxide solution.

To a solution of the amide (20) (50mg.) in methanol (1ml.) was added a solution of potassium hydroxide in methanol (30% by weight, 3ml.). The resultant solution was stirred at room temperature for 24 hours after which time t.l.c. analysis (20% ether/60-80 petroleum ether) indicated very little reaction. The same solution was then refluxed for 4.5 hours but again, t.l.c. analysis indicated that very little hydrolysis had occurred. Subsequent refluxing for a period of 12 hours resulted in only a small amount of polar material being formed.

4). Potassium hydroxide in ethylene glycol.

To a solution of the amide (20) (97mg.) in ethylene glycol (15ml.) was added potassium hydroxide pellets (2.25gm.). The resultant solution was refluxed for 6.5 hours. Water (120ml.) was then added and the solution was extracted with ether (3 x 100ml.). The ethereal solution was extracted with dilute hydrochloric acid solution (2.5M, 2x25ml.) and the acidic extracts basified by additions of concentrated aqueous potassium hydroxide solution with cooling. The resultant basic solution was saturated with sodium chloride and extracted with ether (3x100ml.). The ether extracts were washed with saturated brine solution and dried over anhydrous potassium carbonate. Careful removal of solvent under reduced pressure yielded a slightly yellow coloured liquid (42mg.) whose t.l.c. characteristics (20% ether/60-80 petroleum ether) indicated a mixture of a polar and a relatively non-polar compound. This product was not investigated

further at this stage, however, subsequent work showed that the aforementioned non-polar product arose solely from the use of impure diethyl ether.

5). Methyl fluorosulphonate.

This reaction was monitored by observing the n.m.r. spectrum of a solution of the amide (20) (50mg.) with methyl fluorosulphonate ('Magic Methyl') (30 $\mu$ .l.) in deuteriochloroform (0.5ml.). However, both the  $^1\text{H}$  and  $^{19}\text{F}$  resonance spectra indicated that, even after a period of 3 days, no methylation of the amide was occurring.

6). Potassium t-butoxide in tetrahydrofuran

A solution of the amide (20) (185mg.) in dry, redistilled tetrahydrofuran (3ml.) was cooled to 0°C in an ice bath. To this cooled solution was added dropwise, with stirring, a solution of potassium t-butoxide (450mg.) in dry tetrahydrofuran (10ml.) over a period of 10 minutes. After stirring at 0°C for a further 50 minutes, the solvent was carefully removed under reduced pressure to leave a white solid. To the solid was added ether (100ml.) and water (10ml.) and, after thorough shaking in a separating funnel, the aqueous layer was run off and discarded. The remaining ether layer was extracted with dilute hydrochloric acid solution (2.5M, 2x50ml.) and the acidic extracts basified by the addition of concentrated aqueous potassium hydroxide solution with cooling. The resultant basic solution was saturated with sodium chloride and extracted with ether (3x100ml.). The ether extracts were washed with saturated brine solution (50ml.) and dried over anhydrous potassium carbonate. Careful removal of solvent under

reduced pressure yielded a colourless liquid (111mg.) with a pungent amine smell. T.l.c. analysis (20% ether/60-80 petroleum ether) indicated that complete hydrolysis to polar material had occurred. This material was positively identified as 2,2,3,4,5,5-hexamethyl-3-pyrroline (7) first by making its picrate salt and comparing its melting point with that of authentic picrate and secondly by oxidation to the corresponding nitroxide and comparison of its t.l.c. characteristics with those of the authentic nitroxide.

a). Picrate derivative.

To a solution of the product (50mg.) in ethanol (0.5ml.) was added a cold saturated solution (1ml.) of picric acid in ethanol. The resultant solution was heated over a steam bath for a few minutes and was then allowed to crystallise. Crystals formed which were separated, washed with cold ethanol, followed by petroleum ether (40-60) and then recrystallised from methanol to yield yellow needles, m.p. 235-240°C. A picrate salt made from an authentic sample of the amine (7) in a similar manner had a m.p. 235-240°C.

b). Oxidation to nitroxide

To a solution of the product (40mg.) in methanol (1ml.) was added, with stirring, sodium tungstate dihydrate (1.5mg.), the disodium salt of ethylenediamine tetraacetic acid (2.3mg.) and hydrogen peroxide (30%, 0.5ml.). After stirring at room temperature for about 30 hours the solution was transferred to a small separating funnel and ether (10ml.) and dilute aqueous sodium hydroxide solution (1M, 2ml.) were added. After separation from

the aqueous phase, the organic extract was washed with saturated brine solution (5ml.) and dried over anhydrous potassium carbonate. Careful removal of the solvent under reduced pressure using a Vigreux column yielded a red/orange semi-crystalline product (16.4mg.).

Similarly, an authentic sample of the amine (7) was oxidised and t.l.c. comparison (30% ether/60-80 petroleum ether) of the two oxidation products revealed identical nitroxide components in each.

### 3,4-Dimethylene-2,2,5,5-tetramethylpyrrolidine (8).

A solution of the amide (23) (1.86gm) in dry, redistilled tetrahydrofuran (50ml.) was cooled to 0°C in an ice bath. To this cooled solution was added dropwise, with stirring, a solution of potassium t-butoxide (2.21gm.) in dry tetrahydrofuran (100ml.) over a period of 10 minutes. After stirring at 0°C for a further 20 minutes, the solvent was carefully removed under reduced pressure using a Vigreux column. Water (50ml.) and ether (1000ml.) were added to the resultant solid mass and after shaking in a separating funnel, the aqueous layer was run off and discarded. The ethereal layer was extracted with dilute hydrochloric acid solution (2.5M, 3x100ml.) and the acidic extracts basified by the addition of concentrated aqueous potassium hydroxide solution with cooling. The resultant basic solution was saturated with sodium chloride and extracted with ether (3x250ml.). The ether extracts were washed with saturated brine solution (100ml.) and dried over anhydrous potassium carbonate. Careful removal of the solvent under reduced



pressure using a Vigreux column yielded a slightly yellow-coloured liquid (0.78g.m.). This material was used without further purification in the final stage.

Further purification could be effected by distillation under reduced pressure yielding a colourless liquid, b.p. 50-55°C/12mm.

$\nu_{\text{max}}$ . (liq. film) = 3040, 1360, 1170, 995 and 885 $\text{cm}^{-1}$ .

$\lambda_{\text{max}}$ . (petroleum ether) = 244nm. ( $\epsilon=5960$ )

$\tau(\text{CDCl}_3)$  = 8.69 (12H, singlet),  $(\text{CH}_3)_2\text{-C-N}$ , 5.13 (2H, singlet),  $\text{CH}_2=\text{C-}$ , 4.57 (2H, singlet),  $\text{CH}_2=\text{C-}$ .

Analysis; Found : C, 79.32; H, 11.49; N, 9.08%.

$\text{C}_{10}\text{H}_{17}\text{N}$  Requires : C, 79.41; H, 11.33; N, 9.26%.

### 3,4-Dimethylene-2,2,5,5-tetramethylpyrrolidine-1-oxyl (5)

To a solution of the crude amine (8) (0.78gm) in dry methylene chloride (31ml.) was added disodium hydrogen phosphate (1.3gm.). The solution was cooled to 0°C in an ice bath and with stirring a solution of m-chloroperbenzoic acid (0.97gm.) in dry methylene chloride (47ml.) was added dropwise over a period of 30 minutes. After stirring at 0°C for a further 1.5 hours, methylene chloride (100ml.) was added and the solution washed with aqueous sodium bicarbonate solution (5%, 50ml.). The aqueous washings were discarded and the organic extract washed with saturated brine solution (25ml.) and then dried over anhydrous potassium carbonate. Careful removal of the solvent under reduced pressure using a Vigreux column yielded the yellow-orange crystalline nitroxide (5) (0.736gm.). Purification was effected by preparative t.l.c. (30% ether/60-80 petroleum ether).

m.p. 92-94°C.

$\nu_{\text{max}}$ . (Nujol mull) = 1370, 1355, 1185, 1165, 920, 910, 800 and 730  $\text{cm.}^{-1}$ .  $a_{\text{N}} = 13.7 \text{ Oe.}$ ,  $g = 2.006$  ( $\text{CCl}_4$ )  
 $\tau(\text{CDCl}_3 + \text{hydrazobenzene}) = 8.70$  (12H, singlet),  $(\text{CH}_3)_2\text{-C-N}$ , 5.08 (2H, singlet),  $\text{CH}_2=\text{C-}$ , 4.52 (2H, singlet),  $\text{CH}_2=\text{C-}$ .  
 $\lambda_{\text{max}}$ . (hexane) = 237 n.m. ( $\epsilon=5200$ ) and c.a. 430 n.m. ( $\epsilon=8$ )  
 $\text{M}^+$  or  $\text{M}^++1$  not observed. Parent ion is  $\text{M}^+-30 = 136$

Significant ions at  $m/e = 121, 120, 96, 95$

Analysis ; Found : C, 72.54; H, 9.53; N, 8.35%.

$\text{C}_{10}\text{H}_{16}\text{NO}$  Requires : C, 72.25; H, 9.70; N, 8.43%.

Diels-Alder reactions of 1-trifluoroacetyl-3,4-dimethylene-2,2,5,5-tetramethylpyrrolidine (23).

1). with maleic anhydride.

A solution of the diene trifluoroacetamide (23) (100mg.) with an equimolar amount of maleic anhydride (40mg.) in benzene (5ml.) was refluxed for 14 hours. After cooling, the solvent was removed under reduced pressure leaving a colourless solid. Recrystallisation from benzene yielded the colourless crystalline adduct (45) (156mg.) m.p. 173-175°C.

$\nu_{\text{max}}$ . (Nujol) = 1846, 1776, 1652, 1460 and 1200  $\text{cm.}^{-1}$ .  
 $\tau(\text{CDCl}_3) = 8.52$  (6H, singlet),  $(\text{CH}_3)_2\text{-C-N}$ , 8.48 (6H, singlet),  $(\text{CH}_3)_2\text{-C-N}$ , 7.43 (4H, broad singlet),  $\text{C=C-CH}_2\text{-CH-}$ , 6.39 (2H, broad singlet),  $-\text{CH}_2\text{-CH-CO-}$

Analysis; Found : C, 55.79; H, 5.26; N, 3.99%:

$\text{C}_{16}\text{H}_{18}\text{NO}_4\text{F}_3$  Requires : C, 55.65; H, 5.25; N, 4.05%.

2). with tetracyanoethylene

A solution of the trifluoroacetamide diene (23) (100mg.) with an equimolaramount of tetracyanoethylene (52mg.) in freshly distilled tetrahydrofuran (5ml.) was left standing overnight at room temperature. Subsequent removal of solvent under reduced pressure yielded brown coloured crystals. This material was dissolved in benzene (10ml.), animal charcoal added, the solution heated over a steam bath for 40 minutes and then left to stand overnight at room temperature. The solution was then filtered through Celite to give a colourless solution which, after removal of solvent under reduced pressure, yielded colourless crystals. Recrystallisation from benzene afforded the colourless adduct (47) (68.5mg.), m.p. 184°C (decomposition).

$\nu_{\max}$ . (Nujol) = 1820, 1665, 1455, 1200 and 1160 $\text{cm}^{-1}$

$\tau((\text{CD}_3)_2\text{CO}) = 8.30$  (12H, singlet),  $(\text{CH}_3)_2\text{-C-N}$ , 8.34 (4H, singlet),  $-\text{C}=\text{C}-\text{CH}_2-\text{C}(\text{CN})_2$ .

Analysis ; Found : C, 57.49; H, 4.57; N, 18.79%.

$\text{C}_{18}\text{H}_{16}\text{N}_5\text{O}_3\text{F}_3$  Requires : C, 57.59; H, 4.30; N, 18.66%.

3). with dimethyl acetylene dicarboxylate

A solution of the trifluoroacetamide diene (23) (100mg.) with an equimolar amount of dimethyl acetylene dicarboxylate (57.5mg.) in benzene (5ml.) was left standing overnight at room temperature. Subsequent removal of solvent under reduced pressure provided a colourless crystalline solid which was recrystallised from benzene/petroleum ether (40-60) to yield the colourless crystalline adduct (46) (74.7mg.). m.p. 157-158°C.

$\nu_{\max.}$  (Nujol) = 1725, 1715, 1660, 1460, 1280, 1200, 1140 and 1060  $\text{cm.}^{-1}$

$\tau(\text{CDCl}_3)$  = 8.42 (12H, singlet),  $(\text{CH}_3)_2\text{-C-N}$ , 6.93 (4H, singlet),  $-\text{CH}_2-$ , 6.11 (6H, singlet),  $\text{CH}_3\text{-CO}_2-$ .

Analysis ; Found : C, 55.51; H, 5.80; N, 3.68%.

$\text{C}_{18}\text{H}_{22}\text{NO}_5\text{F}_3$  Requires : C, 55.52; H, 5.70; N, 3.60%.

Diels-Alder reactions of 3,4-dimethylene-2,2,5,5-tetramethylpyrrolidine-1-oxyl (5).

1). with maleic anhydride

A solution of the diene-nitroxide (5) (67mg.) with an equimolar amount of maleic anhydride (40mg.) in benzene (5ml.) was left standing at room temperature for about 40 hours. After removing some of the solvent under reduced pressure, yellow crystals precipitated which were filtered off and washed several times with petroleum ether (40-60) to yield the pale yellow (48) (76.6mg.), m.p. 199-201°C (sublimes)

$\nu_{\max.}$  (Nujol) = 1845, 1775, 1460, 1240, 1175, 1100, 1020 and 950  $\text{cm.}^{-1}$ ;  $\lambda_{\max.}$  (EtOH) = 217, 415 nm ( $\epsilon = 7100$ , 5)  
 $a_{\text{N}}$  (benzene) = 14.3 Oe.,  $g = 2.006$

An analytical sample was prepared by sublimation (c a. 180°/0.1mm.)

Analysis ; Found : C, 63.34; H, 6.82; N, 5.31%.

$\text{C}_{14}\text{H}_{18}\text{NO}_4$  Requires : C, 63.62; H, 6.80; N, 5.30%.

2). with dimethyl acetylene dicarboxylate

A solution of the diene-nitroxide (5) (67mg.) with an equimolar amount of dimethyl acetylene dicarboxylate

(57.5mg.) in benzene (5ml.) was left standing at room temperature for 4 days. Subsequent removal of solvent under reduced pressure yielded a yellow solid which was recrystallised from benzene and washed with petroleum ether (60-80) to yield the adduct (49) as yellow needles (50mg.), m.p. 216-218°C.

$\nu_{\text{max}}$ . (Nujol = 1730, 1460, 1265, 1060 and 945 $\text{cm}^{-1}$ )

$a_{\text{N}}$  (benzene) = 14.40e.,  $g = 2.006$

$\lambda_{\text{max}}$ . (EtOH) = 216, 410 nm ( $\epsilon = 5400, 5$ )

Analysis ; Found : C, 62.43; H, 7.06; N, 4.64%.

$\text{C}_{16}\text{H}_{22}\text{NO}_5$  Requires : C, 62.32; H, 7.19; N, 4.54%.

### 3) with tetracyanoethylene

To a solution of the diene-nitroxide (5) (67mg.) in freshly distilled tetrahydrofuran (5ml.) was added an equimolar amount of tetracyanoethylene (52mg.). There was an instantaneous reaction with the formation of an intense emerald green colour which darkened after a few minutes to a burgandy red and subsequently to a permanent dark brown colour. T.l.c. analysis (30% ether/60-80 petroleum ether) of this solution was not at all informative.

### 4). with diethyl azodicarboxylate

An equimolar solution of the diene-nitroxide (5) (67mg.) with diethyl azodicarboxylate (70mg.) in benzene (5ml.) was left standing at room temperature. After approximately 20 hours, t.l.c. analysis (30% ether/60-80 petroleum ether) indicated the presence of significant amounts of the starting nitroxide (5). Therefore, trifluoroacetic acid (a few drops) was added and the solution left standing at room temperature for a further

3 days. The solvent was removed under reduced pressure to yield an orange crystalline mass which was recrystallised from benzene/60-80 petroleum ether to yield the adduct (50) as yellow crystals (92.3mg.), m.p. 117-118°C.

$\nu_{\text{max}}$ . (Nujol) = 1725, 1460, 1410, 1215, 1180, 1125, 1080 and 760  $\text{cm}^{-1}$

$a_{\text{N}}$  (benzene) = 14.5 Oe.,  $g = 2.006$

$\lambda_{\text{max}}$ . (EtOH) = 219, 412 nm ( $\epsilon = 4800, 7$ )

Analysis ; Found : C, 56.45; H, 7.73; N, 12.39%.

$\text{C}_{16}\text{H}_{26}\text{N}_3\text{O}_5$  Requires : C, 56.45; H, 7.70; N, 12.34%.

New York, 1971

G.H. Griffith and H.A. Scheraga, *Proc. Nat. Acad. Sci. U.S.A.*, **30**, 5, 1960.

E.J. Stone, I. Mochan, P.L. Hurdle and H.H. Gammell, *Proc. Nat. Acad. Sci. U.S.A.*, **50**, 1960, 1960.

For reviews of this subject see: G.F. Reed, *J. Polym. Sci.*, Part **1**, **11**, 417 and 1203, 1960.

For a review of this subject see: G. Scott, *Macromol. Chem. Rapid Commun.*, Supplement, **1**, 1980.

For leading references see: I.I. Abramite and

REFERENCES.

1. A.R. Forrester, J.M. Hay and R.H. Thomson, Organic Chemistry of Stable Free Radicals, Chap. 5, Academic Press, 1968.
2. E.G. Rozantsev, Free Nitroxyl Radicals, Plenum Press, 1970.
3. D.J. Kosman and L.H. Piette, J.C.S. Chem. Comm. 926, 1969.
4. H.M. McConnell and B.G. McFarland, Quart. Revs. Biophysics, 3, 91, 1970.  
O.H. Griffith and A.S. Waggoner, Accounts Chem. Res., 2, 17, 1969.  
P. Jost and O.H. Griffith, Methods in Pharmacology, Chap. 2, C. Chignell, Ed., Physical Methods in Pharmacology, Vol. 2, Appleton-Century-Crofts, New York, 1971
5. O.H. Griffith and H.M. McConnell, Proc. Nat. Acad. Sci. U.S., 55, 8, 1966.
6. T.J. Stone, T. Buckman, P.L. Nordio and H.M. McConnell, Proc. Nat. Acad. Sci. U.S., 54, 1010, 1965.
7. For reviews of this subject see;- G.P. Rabold, J. Polym. Sci., Part A-1, 7, 1187 and 1203, 1969.
8. For a review of this subject see:- G. Scott, European Polymer Journal, Supplement, 189, 1969.
9. For leading references see:- I.T. Brownlie and K. U. Ingold, Canad. J. Chem., 45, 2427, 1967.
10. G.F. Hennion and C.V. DiGiovanna, J. Org. Chem., 30, 2645, 1965.
11. G. Stork, S. Malhotra, H. Thomson and M. Uchibayashi, J. Amer. Chem. Soc., 87, 1148, 1965.

12. G.F. Hennion and R.H. Ode, J. Org. Chem., 31, 1975, 1966.
13. D.W. Gilmour and J.S. Roberts, Unpublished Results.
14. L. Horner and E.H. Winkelmann in Newer Methods of Preparative Organic Chemistry, Vol. 111, Ed. W. Foerst.
15. B.C. Challis and J.A. Challis in The Chemistry of Amides, J. Zabicky, Ed., S. Patai, Series Ed., 1970.
16. P.A.S. Smith, The Chemistry of Open Chain Organic Nitrogen Compounds, Vol. 1, Benjamin, 1965.
17. C. Sandris and G. Ourisson, Bull. Soc. Chim. France, 345, 1958.
18. J.F.W. McCombie in Adv. in Org. Chem, Methods and Results, 3, 191, 1963.
19. A. Taurog, S. Abraham and I.L. Chaikoff, J. Amer. Chem. Soc., 75, 3473, 1973.
20. Y. Liwschitz, R.D. Irsay and A.I. Vincze, J. Chem. Soc., 1308, 1959.
21. H. Perst, Oxonium Ions in Organic Chemistry, Verlag Chemie, Academic Press, 1971.
22. H. Muxfeldt and W. Rogalski, J. Amer. Chem. Soc., 87, 933, 1965.
23. M.G. Ahmed and R.W. Alder, J.C.S. Chem. Comm., 389, 1969.
24. M.G. Ahmed, R.W. Alder, G.H. James, M.L. Sinnott and M.C. Whiting, J.C.S. Chem. Comm., 1533, 1968.
25. C.G. Krespan and W.J. Middleton, Fluorine Chem. Rev., 1 (1), 145, 1967.
26. J.A. Marshall, C.T. Buse and D.E. Seitz, Synthetic Communications, 3 (1), 85, 1973.



27. B.A<sup>o</sup>. Andersson and G. Folsch, Chemica Scripta, 2,21, 1972.
28. C. Sandris and G. Ourisson, Bull. Soc. Chem. France, 350, 1958.
29. W.J. Bailey and S.S. Miller, J. Org. Chem., 28, 802, 1963.
30. Y. Gaoni, Tet. Lett., 2361, 1973.  
S. Sadeh and Y. Gaoni, Tet. Lett., 2365, 1973.
31. W.J. Middleton, R.E. Heckert, E.L. Little and C.G. Krespan, J. Amer. Chem. Soc., 80, 2783, 1958.  
D.N. Dhar, Chem Rev., 67, 611, 1967.
32. A. Rodgman and G.F. Wright, J. Org. Chem., 18, 465, 1953.
33. T. Mill and R.S. Stringham, Tet. Lett., 1853, 1969.
34. N.R. Easton, Abstracts of papers presented at the 138th. National Meeting of the American Chemical Society, New York, N.Y. Sept. 1960, p. 460.

1948.

Recently, there has been an increasing interest in the  
 study of preparing polymeric systems. In fact,  
 in 1947, some progress has been made in this field.  
 For example, the methacrylate nitrocellulose has  
 been prepared in a laboratory setting. This  
 material has been found to be a very good  
 material for use in the preparation of  
 films.

## SECTION TWO

1. The first part of this section is devoted to a  
 study of the polymerization of styrene  
 in the presence of various initiators. The  
 results show that the rate of polymerization  
 is increased by the presence of these  
 initiators. This is due to the fact that  
 these initiators are able to break down  
 into free radicals which then initiate the  
 polymerization process. The results also  
 show that the molecular weight of the  
 polymer is increased by the presence of  
 these initiators. This is due to the fact  
 that these initiators are able to break  
 down into free radicals which then initiate  
 the polymerization process. The results  
 also show that the molecular weight of the  
 polymer is increased by the presence of  
 these initiators. This is due to the fact  
 that these initiators are able to break  
 down into free radicals which then initiate  
 the polymerization process.

CHAPTER 1.DISCUSSION.

Recently, there has been an interest shown in the possibility of preparing polymeric nitroxide radicals<sup>1,2</sup> and to date, some progress has been made towards this end. For example, the methacrylate nitroxide (1) has been prepared and polymerised in the presence of phenylmagnesium bromide although only to low molecular weight (1050).<sup>1</sup>

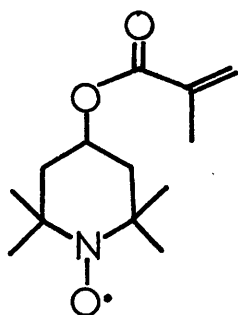

1

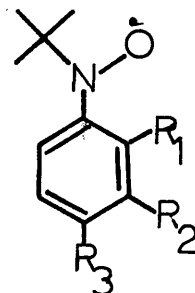

- 2 a.  $R_1 = R_2 = H$ ,  $R_3 = -CH=CH_2$   
 b.  $R_1 = R_3 = H$ ,  $R_2 = -CH=CH_2$   
 c.  $R_2 = R_3 = H$ ,  $R_1 = -CH=CH_2$

Furthermore, in a study of the polymerisation of the o-, m- and p- vinylphenyl nitroxides (2), although the nitroxides (2b,c) did not undergo anionic polymerisation themselves, they did form copolymers with styrene and  $\alpha$ -methylstyrene under anionic conditions<sup>2</sup>. Again, the incorporation of nitroxide was low (ca. 1%). We have always considered with interest the possibility of copolymerising a suitably substituted nitroxide radical with another monomer. Such a copolymer, if it could be produced with a small

proportion (ca. 5%) of the nitroxide randomly distributed along the polymer chain, would be of interest particularly from two standpoints. First, it would provide a polymer which had an antioxidant covalently bound to the polymer chain and therefore not subject to 'leaching out' as is often the case when polymers are stabilized in the usual way by physically adding the antioxidant<sup>3</sup>. Secondly the covalently bound nitroxide would be a useful spin-probe for the study of polymer motion since the e.p.r. spectrum of the nitroxide would be a direct reflection of the motions of the polymer chain as opposed to the 'conventional' nitroxide spin-probe whereby the e.p.r. spectrum of the physically added nitroxide is used to infer information about the polymer motions<sup>4</sup>. Using a nitroxide co-monomer would, however, restrict the possible methods of copolymerisation. Clearly, free radical polymerisation is not applicable to these compounds and since nitroxides react with acids in general<sup>5</sup> and form complexes with Lewis acids in particular<sup>6</sup>, cationic polymerisation is unlikely to be effective<sup>2</sup>. Although nitroxides can be polymerised anionically, there is some evidence to suggest that they react with anions thus inhibiting polymerisation by the possible mechanism outlined below<sup>2</sup>.

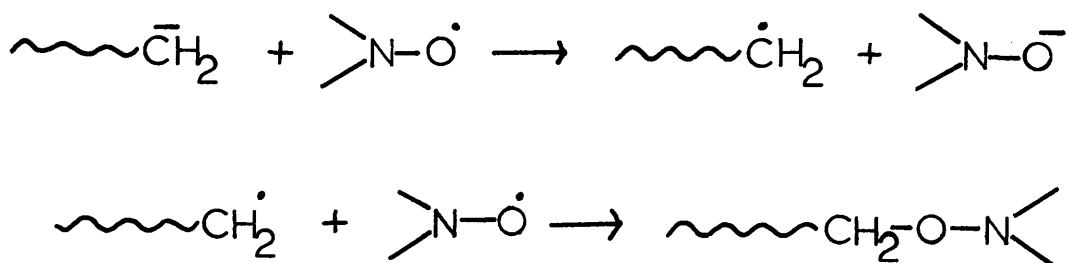

This is not altogether surprising since it is well known that nitroxides can be reduced either to the corresponding amine or hydroxylamine depending on the strength of the reducing agent used<sup>5</sup>.

Nevertheless, we believed this to be a promising area of research and subsequently surveyed the literature for a nitroxide radical suitable for polymerisation studies. It was decided that the, as yet unreported, allyl nitroxide (3) would be an appropriate candidate from the point of view of

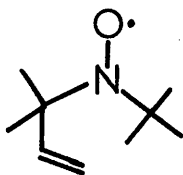

3

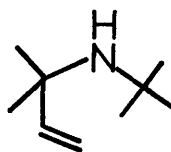

4

substitution, stability and above all, ease of preparation. However, as is so often the case in chemical research, the intended avenue of investigation is intersected by a number of chemically unmapped side roads which offer the investigator interesting and rewarding diversions. Such was the case with the nitroxide (3) as will now be discussed.

The synthetic route to the allyl nitroxide (3) was simple, involving first of all, the preparation of the known acetylenic amine (5)<sup>7</sup> by alkylation of t-butylamine with 1,1-dimethylpropargyl chloride in the presence of aqueous

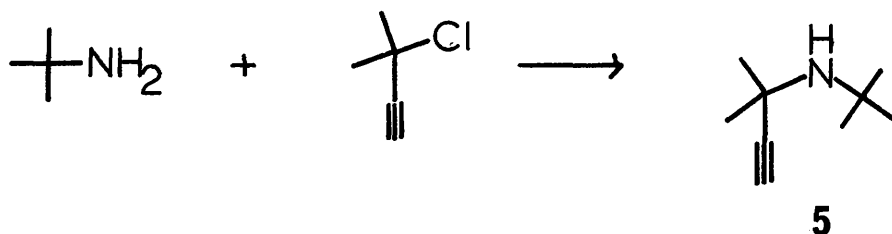

potassium hydroxide solution. Birch-type reduction of the acetylenic amine (5) yielded the known olefinic amine (4)<sup>7</sup> which was readily oxidised to the nitroxide (3) either by m-chloroperbenzoic acid or sodium tungstate/hydrogen peroxide solution. In the event, the nitroxide (3) was most conveniently prepared by the latter method over a few days and was isolated as an initially deep red liquid with a strong camphoraceous odour. Purification of the crude red liquid was attempted, in the first instance, by distillation at atmospheric pressure. However, heating a portion of the material to ca. 100°C in a micro-distillation unit resulted in a quite spectacular transformation. The deep red material rapidly darkened to a deep brown colour whereupon a volatile blue component distilled across. This blue distillate subsequently crystallised to a colourless solid. In fact, this colourful, albeit patriotic, transformation heralded the diversion of attention from the intended area of research to the fascinating chemistry involved in the decomposition of the allyl nitroxide (3) and some related compounds. Subsequent investigations into this area were to provide a seemingly endless myriad of fascinating problems and intriguing mechanistic speculation which

were to bear no relation to the structural simplicity of the initial compound.

If a sample of the nitroxide (3), either neat or in solution, was allowed to stand at room temperature in an open vessel, the colour gradually changed over a few hours from deep red through brown to light green. If the vessel was sealed then the deep red colour of the nitroxide changed to a turquoise blue over the same period of time. Irrespective of whether the vessel was sealed or not, substantial decomposition took place after standing overnight at room temperature and subsequent t.l.c. analysis indicated the formation of two major decomposition products less polar than the starting nitroxide. Decomposition of the nitroxide (3), either as neat liquid or in solution, was essentially complete after 3 days at room temperature and the products were isolated by careful preparative t.l.c. and characterised principally by their n.m.r. spectra. The major, less polar, component is a colourless oil (35% yield) and was identified by its n.m.r. spectrum as N-(1,1-dimethylallyl)-O-(3,3-dimethylallyl)-N-t-butylhydroxylamine (6). A combination of n.m.r. and high resolution mass spectra identified the minor, relatively more polar component, (25% yield) as the epoxide of (6), namely N-(1,1-dimethylallyl)-O-(2,3-epoxy-3-methylbutyl)-N-t-butylhydroxylamine (7). The structure of the major

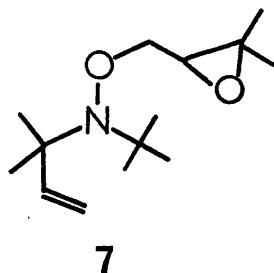
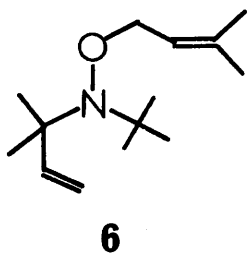

decomposition product (6) itself gives a clue to the mode of decomposition of the nitroxide (3). Clearly the most likely mechanism is one involving initial cleavage of the C-N bond of the nitroxide (3) to generate an intermediate dimethylallyl radical and 2-nitroso-2-methylpropane (8). As shown below, this could be followed by trapping of the dimethylallyl radical

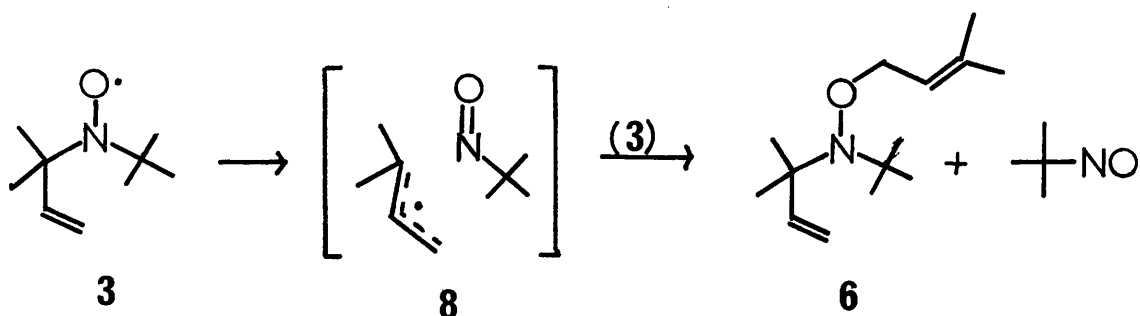

by another nitroxide radical in the sterically more favoured sense to yield the hydroxylamine (6) and 2-nitroso-2-methylpropane. The mode of formation of the epoxide (7) is somewhat more obscure until it is realised that, in the presence of oxygen, alkyl radicals readily react forming alkylperoxy radicals which can add to double bonds forming epoxides<sup>8</sup>. Thus the allyl radicals could react with atmospheric oxygen to form one or both of the possible allylperoxy radicals (9). Addition of an allylperoxy radical to the double bond of the hydroxylamine (6) would generate the intermediate



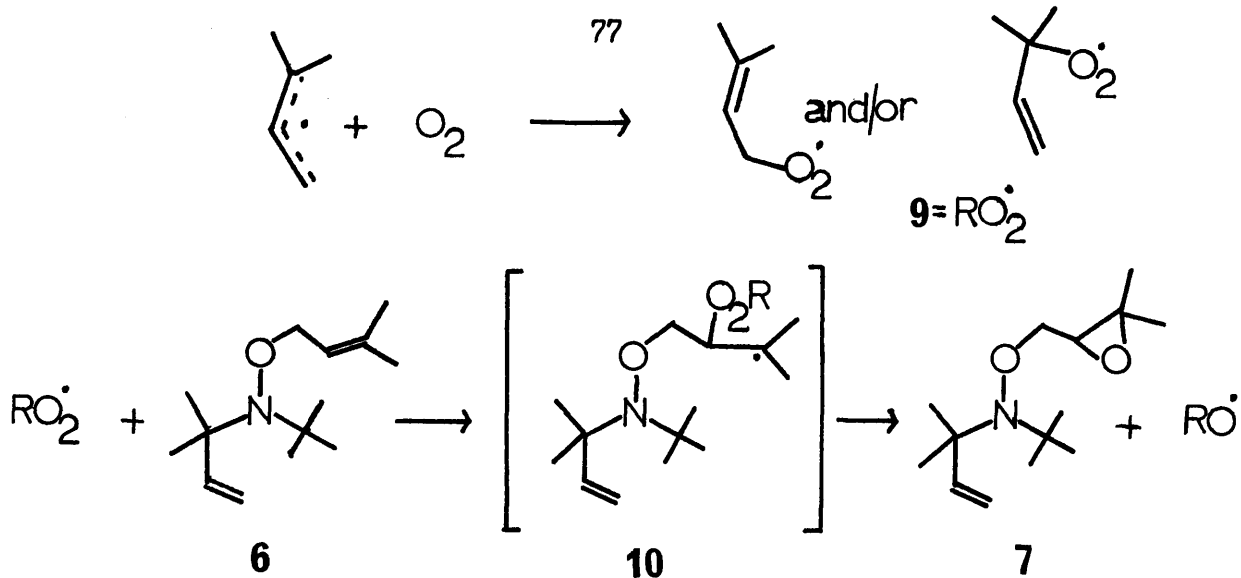

radical (10) which could disproportionate into the epoxide (7) and an alkoxy radical. The alkoxy radicals are expected to react like peroxy radicals to form alcohols and ethers<sup>8</sup> however, neither of these products was detected in the decomposition mixture. The rationale as to why epoxidation occurs at only one double bond must simply lie in the relatively greater stability of the tertiary radical (10) over the secondary radical (11) which would be formed if addition

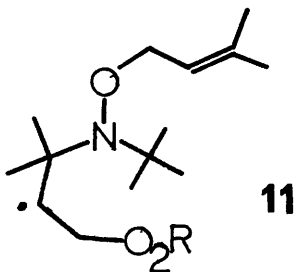

of the allylperoxy radical took place at the mono-substituted double bond. Confirmation of the role of molecular oxygen in the formation of the epoxide (7) was obtained by allowing the nitroxide (3) to decompose under completely anaerobic conditions. A solution of the pure nitroxide (3) in carbon tetrachloride was divided into two portions. One portion was allowed to decompose at room

temperature in the presence of air while the other portion was similarly allowed to decompose but in an atmosphere of oxygen-free nitrogen. After a period of 2.5 days, in each case the products were isolated by preparative t.l.c. and the respective quantities of the hydroxylamine (6) and the epoxide (7) noted. With atmospheric oxygen present, decomposition produced the hydroxylamine (6) and the epoxide (7) in similar yields as before. However, under anaerobic conditions, the yield of the hydroxylamine (6) greatly increased at the expense of the epoxide (7) (56% and 3.7% yields respectively). Notwithstanding the small amounts of epoxide (7) formed during the anaerobic decomposition, which probably resulted from a non-rigorous exclusion of oxygen, this experiment clearly demonstrates that the epoxide (7) results from the presence of oxygen during decomposition.

It was considered that a simple approach to a verification of the structure of the epoxide (7) was to attempt the epoxidation of the hydroxylamine (6) with *m*-chloroperbenzoic acid. Since it is well known that the reactivity of double bonds towards the electrophilic oxygen of a peracid increases with increasing substitution<sup>9</sup>, it was considered that the trisubstituted double bond of (6) would be selectively and cleanly epoxidised to yield (7). In the event,

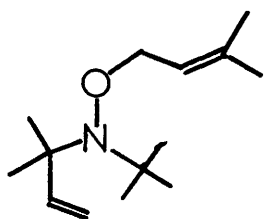

6

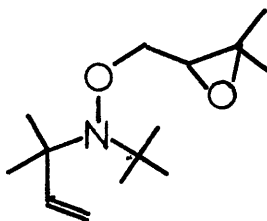

7

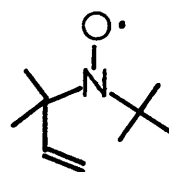

3

no epoxidation of the hydroxylamine (6) occurred as a result of treatment with m-chloroperbenzoic acid even after two days at room temperature. Besides the remaining starting material (6), the major product was in fact the nitroxide (3) as evidenced by t.l.c. comparison with authentic material. This presumably arises via attack of electrophilic oxygen on the lone pair electrons of nitrogen forming the N-oxide (12) which could fragment to the nitroxide (3) and, initially, a  $\beta,\gamma$ -

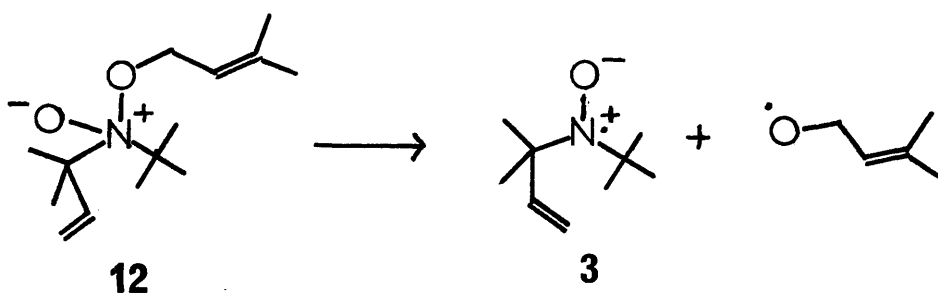

unsaturated alkoxy radical. Such oxidative cleavages are characteristic of cyclic hydroxylamines<sup>10</sup> such as (13) which

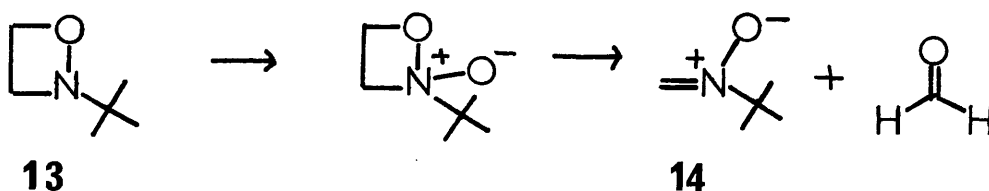

yields formaldehyde and the nitron (14). Evidently the nitrogen atom of the hydroxylamine (6) was more reactive towards the per-acid than was the double bond. This effect has previously been observed in unsaturated amines<sup>9</sup> viz. the amine (15) is readily converted into its N-oxide (16) by treatment with perphthalic acid<sup>11</sup>.

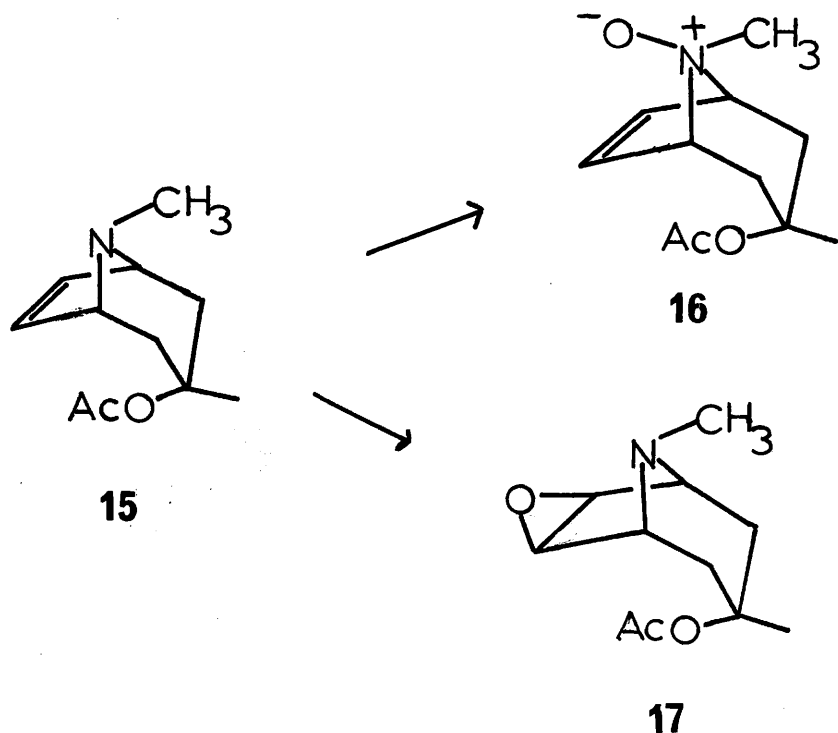

However, when the same amine (15) is treated with trifluoroperacetic acid in the presence of an equivalent of trifluoroacetic acid, the product is the epoxide (17). By the same token, it was considered that oxidation of the hydroxylamine (6) in the presence of acid might yield the required epoxide (7) since the nitrogen lone pair electrons would be bound by protonation. It was found however, that reaction of m-chloroperbenzoic acid with the hydroxylamine (6) in the presence of glacial acetic or perchloric acid did not alter the course or the rate of the reaction.

With reference to the attempted distillation of the nitroxide (3), t.l.c. examination of the dark brown coloured material remaining in the distillation flask revealed the presence of two major components. The minor of these two was identified as the hydroxylamine (6) by

t.l.c. comparison with authentic material while the major product was identified by its n.m.r. spectrum as the isomeric hydroxylamine, N,O-di-(3,3-dimethylallyl)-N-t-butylhydroxylamine (18). No significant amounts of the

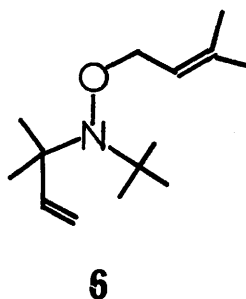
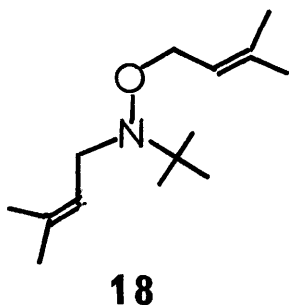

epoxide (7) were formed. This finding that the hydroxylamine (18) was the major product of thermolysis initially signalled that a different mechanism operated at ca. 100°C however, subsequent work (see Chapter 2 of this section) showed that the hydroxylamine (18) was in fact formed by the thermal rearrangement of (6) and therefore was not a primary decomposition product of the thermolysis of the nitroxide (3). The blue distillate which subsequently crystallised to a colourless solid was identified as 2-nitroso-2-methylpropane (monomer and dimer respectively) by n.m.r. analysis of a sample of the blue liquid and by comparison of the melting point of the solid dimer with that of authentic material.

Similarly the blue product formed by room temperature decomposition of the nitroxide (3) in a sealed vessel was positively identified as 2-nitroso-2-methylpropane by trapping it on a 'cold finger' condenser at ca. -20°C and recording the n.m.r. of its solution in deuteriochloroform and from the m.p. of its dimer formed by standing in the deep freeze. When the room temperature decomposition is

carried out in an unsealed container, the volatile 2-nitroso-2-methylpropane escapes and therefore no significant blue colouration is observed.

As will be apparent from the preceding discussion, purification of such an unstable nitroxide as (3) proved to be extremely difficult. In the event pure samples were obtained only by column chromatography at  $-40^{\circ}\text{C}$ .

Having thus delineated the principal characteristics of this decomposition, it is necessary at this stage to draw it into some kind of perspective. As chemists, we are constantly seeking for and using simple rules and generalisations, which may or may not involve rationalisations, in our attempts to resolve the vast complexity of this modern science. In the particular field of dialkyl nitroxide radical chemistry, one is often aided and abetted by the simple rule that, a dialkyl nitroxide radical will be stable if the carbon atoms adjoining the nitroxide moiety are fully substituted. As outlined in the Introduction, this is a condition which precludes decomposition via disproportionation to the corresponding nitrene and hydroxylamine. That there are seemingly few exceptions to this rule, particularly in acyclic and monocyclic dialkyl nitroxides, explains our surprise with regard to the facile decomposition of the nitroxide (3). However, this work does illustrate the dangers involved in making blanket generalisations across chemical species irrespective of their particular structure and the need to scrutinize each unit in isolation.

On surveying the literature, one finds there are but two reports of instability in nitroxide radicals

which bear any relevance to the decomposition of the nitroxide (3). Meander and Janzen<sup>12</sup> reported the instability of certain trityl alkyl nitroxides (19) which gave rise to trityl radicals (20) as evidenced by their e.p.r. spectra. Almost every  $\beta$ -disubstituted alkyl nitroxide gave

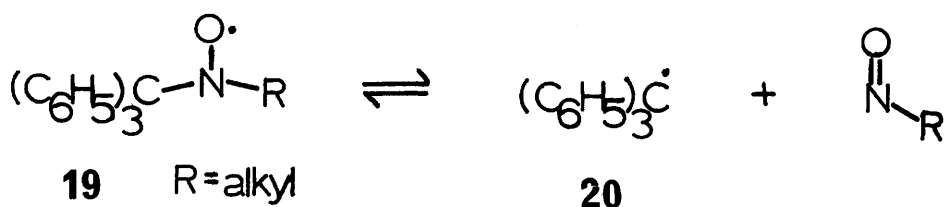

rise to trityl radicals. For example, trityl-2-pentylaminoxyl (21) and trityl-3-pentylaminoxyl (22) are quite unstable at room temperature and in both cases

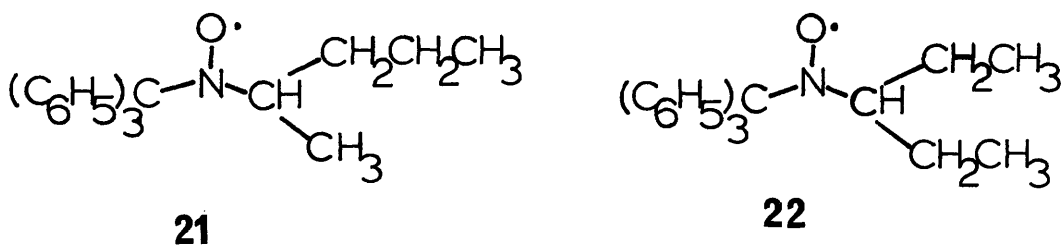

the trityl radical spectrum is detected almost immediately and increases in intensity at the expense of the nitroxide spectrum. Approximate half lines were calculated from the e.p.r. data to be 30 min. and 17 min. for (21) and (22) respectively. Furthermore, the yellow solution of the trityl-t-butyl nitroxide (23) was short

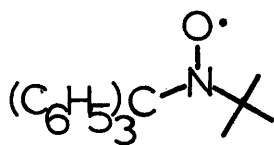

23

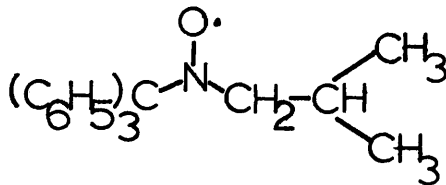

24

lived and turned green presumably as a result of the formation of 2-nitroso-2-methylpropane while a weak trityl radical spectrum was observed. Of the  $\beta$ -monosubstituted nitroxide radicals studied, only the trityl isobutyl nitroxide (24) gave rise to the trityl radical spectrum and only after an extended period of time (approximately 2 hours). On the basis of this evidence, Meander and Janzen suggested that cleavage of the nitroxides into trityl radicals was aided by sterically bulky groups. Moreover, since in some cases, decomposition appeared to cease at a stage where both the nitroxide and trityl radicals are detected, they concluded that the cleavage step was probably reversible.

Preliminary reports by Michon and Rassat<sup>13</sup> indicate that alkyl-*t*-butylnitroxides such as the *t*-amyl-*t*-butyl-nitroxide (25) decompose by fission of the C-N bond

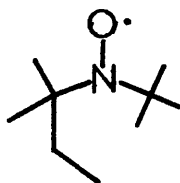

25

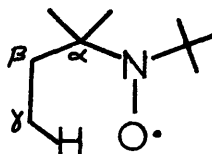

26

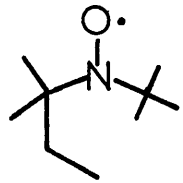
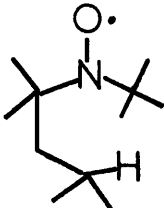
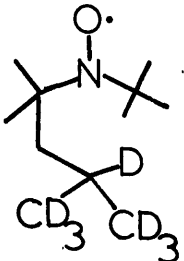
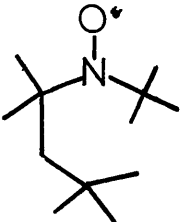

Table 1

Compound	Temp. (°C)	Rate (mole <sup>-1</sup> sec <sup>-1</sup> )	$\Delta E^\ddagger$ (Kcal $\pm 2$ )
 (25)	95	$8.31 \times 10^{-5}$	35
 (27)	85	$1.07 \times 10^{-4}$	22
 (28)	93	$1.15 \times 10^{-4}$	26
 (29)	50	$1.96 \times 10^{-5}$	19

giving rise to the blue colouration of nitroso fragments. While the full mechanistic details have yet to be published, on the basis of deuterium labelling studies, these workers proposed that decomposition involved abstraction of the  $\gamma$ -hydrogen atom of the alkyl side chain via the six-membered cyclic transition state (26). Thus an e.p.r. comparison of the rates of decomposition of the nitroxide (27) and its labelled analogue (28)

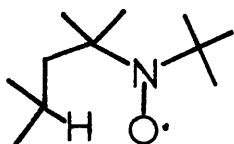

27

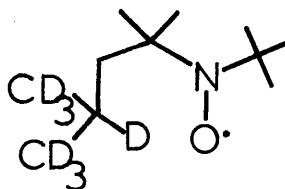

28

revealed a primary isotope effect  $K_H/K_D=6.1$  at  $25^\circ\text{C}$  (see Table 1 opposite), thereby implicating decomposition via the transition state (26). Not all of the alkyl-*t*-butylnitroxides studied by Michon and Rassat could be considered to decompose via intramolecular  $\gamma$ -hydrogen abstraction. For example the nitroxide (29), in which the  $\gamma$ -position is fully substituted, decomposed with a lower energy of activation than did the *t*-amyl-*t*-butylnitroxide (25) while

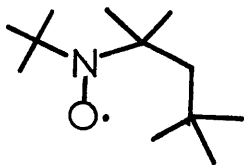

29

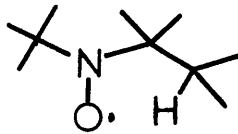

30

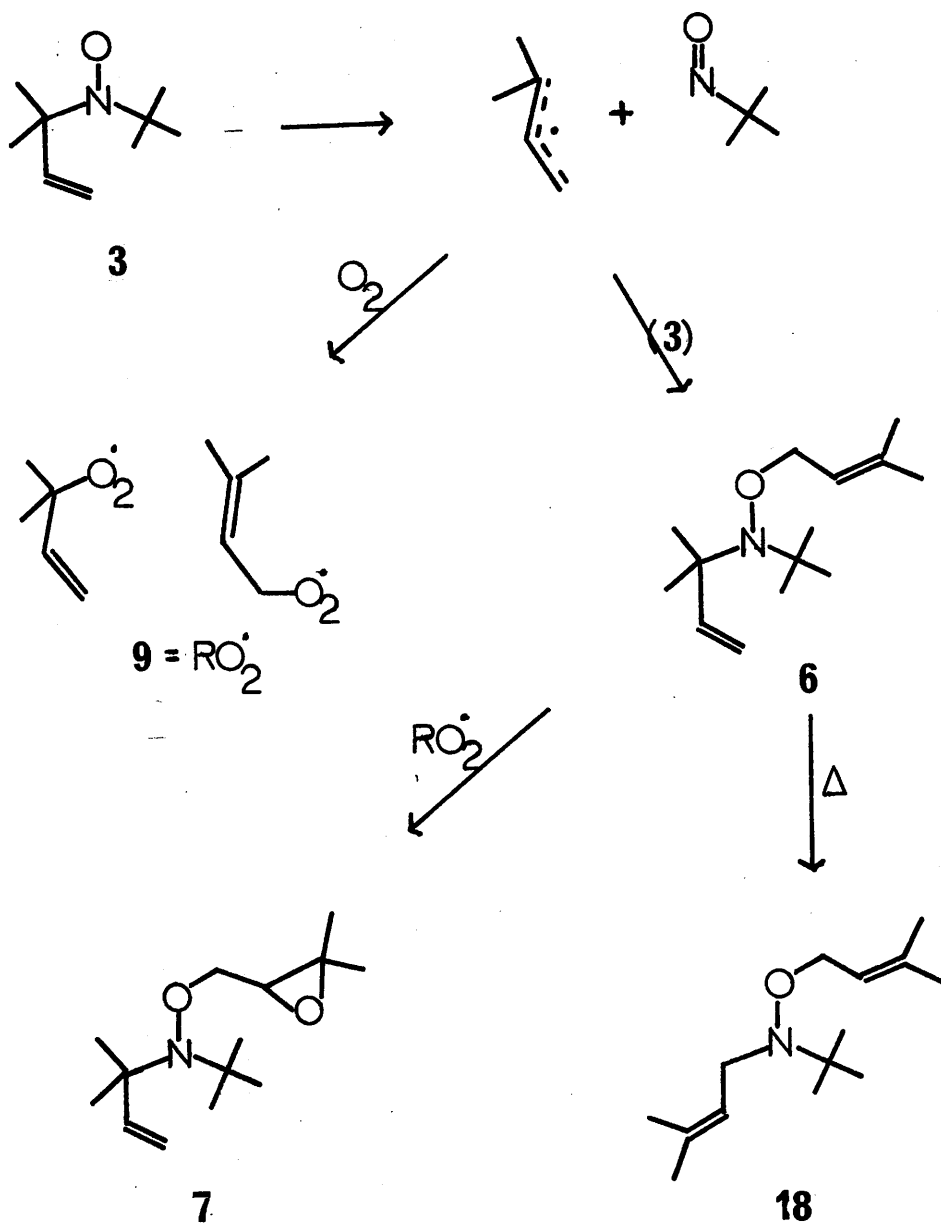

Scheme 1

the nitroxide (30) was too unstable to be isolated. These results hardly support the intramolecular  $\gamma$ -hydrogen abstraction mechanism and in the opinion of the author, judgement should be reserved at least until the full details are published.

Hence the overall picture which emerges is one in which alkyl-t-butyl nitroxides suffer considerable steric interactions which provide a driving force for decomposition via cleavage of the C-N bond to form alkyl radical and nitroso fragments. Moreover this cleavage is greatly facilitated in cases where resonance stabilization can occur in the alkyl radical fragment such as the alkyl-substituted nitroxide (3) and the trityl-t-butyl nitroxides (19).

With particular reference to the allyl-substituted nitroxide (3) the proposed mechanism as established so far can now be summarized (Scheme 1). At room temperature, the nitroxide (3) is unstable and fragments to a dimethylallyl radical and 2-nitroso-2-methylpropane the driving force for this being presumably the relief of steric interactions in (3) aided by resonance stabilization in the alkyl radical fragment. Once formed, the allyl radical is trapped by another nitroxide radical to form the hydroxylamine (6) and, if atmospheric oxygen is present, also by oxygen to form one or other, or both of the possible allylperoxy radicals (9). These peroxy radicals, in turn, bring about oxidation of the hydroxylamine (6) to the epoxide (7). If the decomposing medium is anaerobic, then the allyl radical is trapped exclusively

by the nitroxide (3). The 2-nitroso-2-methylpropane apparently does not react further and, if decomposition occurs in an unsealed vessel, escapes from the medium as a volatile vapour. If decomposition occurs at elevated temperatures (ca. 100°C), then a major product is the hydroxylamine (18) which, as will be discussed in Chapter 2 of this section, is a rearrangement product of the hydroxylamine (6).

It is interesting to note that trapping of the allyl radical by the nitroxide occurs exclusively via the primary (tail) position of the allyl radical ie. there is no evidence of the isomeric hydroxylamine (31) which would be formed by trapping via the tertiary (head) position. Nor is there any evidence which suggests that the

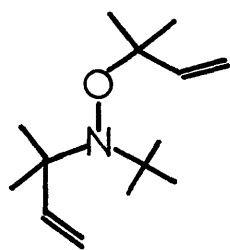
**31**

(hh)

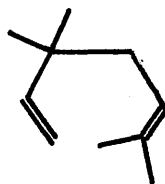
**32**

(ht)

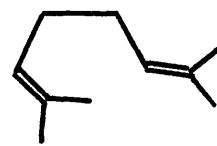
**33**

(tt)

**34**

C<sub>10</sub> dienes (32), (33) and (34), which might have been formed by coupling of dimethylallyl radicals, are produced under any of the conditions of decomposition.

In a related area, the thermolysis and photolysis of azo compounds are known to provide a clean source of free radicals<sup>14</sup> and making use of this fact, Engel and Bishop<sup>15</sup> studied the fate of the dimethylallyl radicals produced by

thermolysis of the azo compound (35). Virtually the entire product (ca. 98% by g.l.c.) was found to consist of the C<sub>10</sub> dienes (32), (33) and (34). Of these products, greater than 50% was accounted for by the

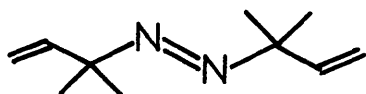

**35**

**32** (hh) 16%

**33** (ht) 30%

**34** (tt) 54%

diene (34) formed by tail to tail coupling of the dimethylallyl radicals. Head to tail coupling of the radicals accounted for 30% of this product while a relatively small amount of material (16%) arose by head to head coupling of the dimethylallyl radicals. As pointed out by the authors, when considering the distribution of C<sub>10</sub> products, three factors are, in principle, of importance. They are (a) the relative spin density at the radical termini, (b) steric effects and (c) product stability. Product stability is considered to be relatively unimportant in view of the exothermicity of radical combination reactions. To be more precise, for radical combination, the high energy of the reactants in relation to the products means that, by Hammond's postulate<sup>16</sup>, the transition state occurs early on the reaction co-ordinate and therefore does not significantly reflect the stability of the products. With regard to the relevance of the relative spin densities at the radical termini, this has been shown to be relatively

unimportant in view of the e.p.r. results of Kochi and Krusic<sup>17,18</sup> which showed that the spin density at the allylic carbon was virtually independent of alkyl substitution. This leaves steric effects as being the principal factor in determining the orientation of coupling of the dimethylallyl radicals. Thus, the product distribution from the thermolysis of the azo compound (35) reflects primarily the greater steric hindrance to recombination of a tertiary site compared to a primary site.

Consistent with this is the fact that 1,1-dichloroallyl radicals formed by treatment of 3,3,3-trichloropropene (36) with copper bronze in pyridine give rise to the coupled products (37), (38) and (39) in the yields 4%, 25% and 71% respectively<sup>19</sup>.

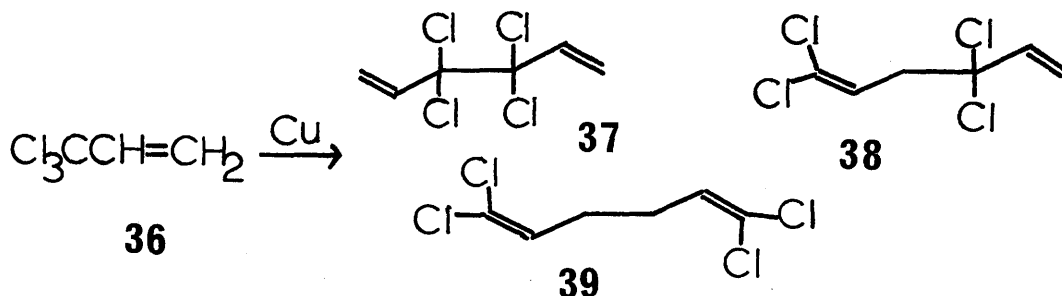

Similarly the exclusive formation of the hydroxylamine (6) over its isomer (31) in the decomposition of the nitroxide (3) must simply reflect the relative steric hindrance towards trapping of the allyl radical via its tertiary site compared to trapping via its primary site.

The total absence of the  $\text{C}_{10}$  dienes from the products of decomposition simply reflects the greater probability of an allyl radical being trapped by a nitroxide than by another allyl radical. This of course is a result of the fact that at any one instant in time, the concentration

of allyl radicals is extremely small in relation to the concentration of nitroxide radicals.

So far, the mechanism has been based on an allyl radical being trapped by another nitroxide radical or, if the decomposing medium is aerobic, by oxygen. However, it is pertinent to consider the possibility of the dimethylallyl radical being trapped by (*ie.* recombining with) 2-nitroso-2-methylpropane in the sterically more favoured sense as outlined in Scheme 2. If, in addition to trapping by nitroxide

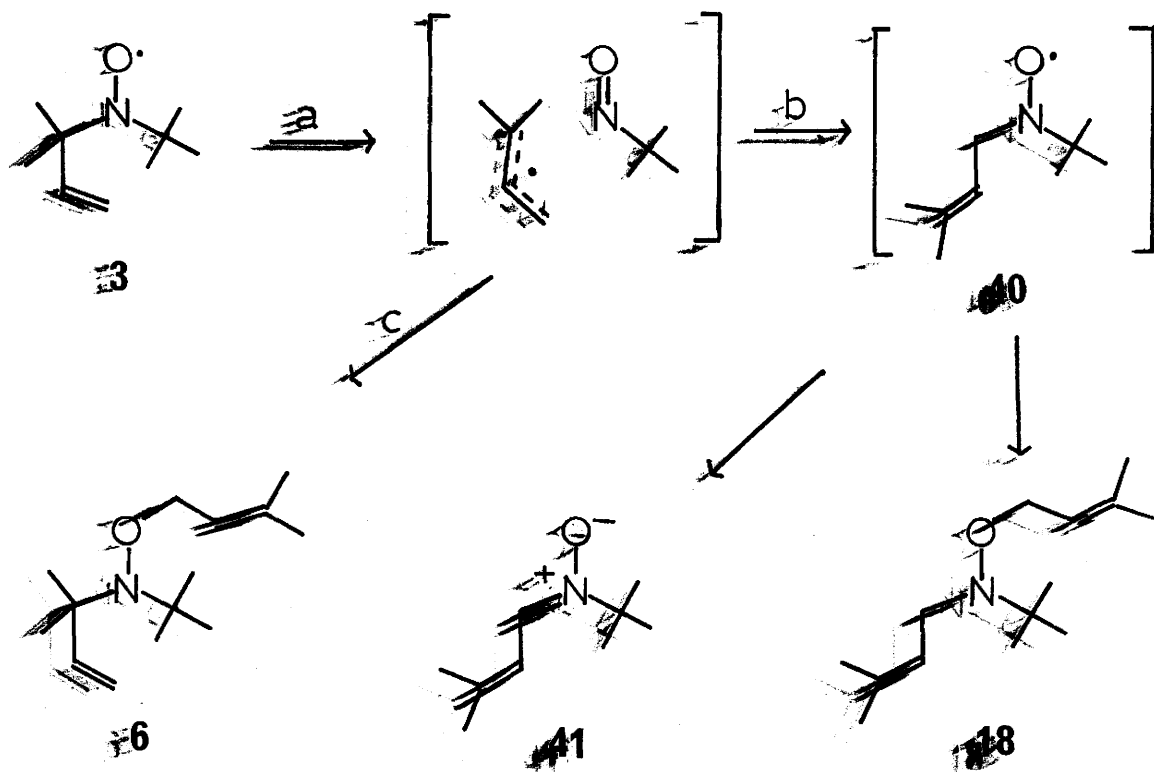

Scheme 2

(3) to form the hydroxylamine (6) (step c), significant recombination of the dimethylallyl radicals and 2-nitroso-2-methylpropane was to occur in the sterically more



favoured sense (step b) then the immediate product would be the nitroxide (40). The subsequent fate of this nitroxide is somewhat problematical since it would depend upon the rate of production of allyl radicals (step a) relative to the rate of decomposition of the nitroxide (40) via disproportionation. If these rates were such that trapping of another dimethylallyl radical was favoured over disproportionation, then the ultimate product would be the hydroxylamine (18). If, on the other hand, disproportionation was favoured, then the products should include the  $\beta,\gamma$ -unsaturated nitrene (41). Indeed the  $\beta,\gamma$ -unsaturated nature of the nitroxide (40) would be expected to render the  $\beta$ -hydrogen atom especially reactive towards abstraction. In any case, no detectable quantities of either the hydroxylamine (18) or the nitrene (41) were observed as a result of the room temperature decomposition of the nitroxide (3). However, it should be pointed out that during room temperature decomposition of the nitroxide (3), at any given time the concentration of 2-nitroso-2-methylpropane will be very small relative to the concentration of the nitroxide (3). Therefore the predominance of step c over step b with the formation of the hydroxylamine (6) may simply reflect the relative concentrations of the nitroxide and nitroso species. In order to test this theory, the nitroxide (3) was allowed to decompose at room temperature in very dilute solution over a period of 3 days. Subsequent examination by t.l.c. revealed the same decomposition products as were formed either from neat liquid or from more concentrated solutions ie. the hydroxylamine (6) and the corresponding

epoxide (7). No detectable amounts of the hydroxylamine (18) or the nitron (41) were formed.

This result leads one inescapably to the conclusion that the nitroxide radical (3) is a better scavenger of dimethylallyl radicals than is 2-nitroso-2-methylpropane a result which bears some relevance to the spin-trapping technique<sup>20,21,22</sup>. Briefly, this powerful technique utilizes the scavenging properties of certain diamagnetic species (usually a nitroso compound or a nitron) in trapping reactive and short-lived paramagnetic species to form relatively more stable nitroxide radicals as described by equations 1 and 2. The e.p.r. spectrum of the nitroxide 'spin-adduct' is used to infer details of the structure

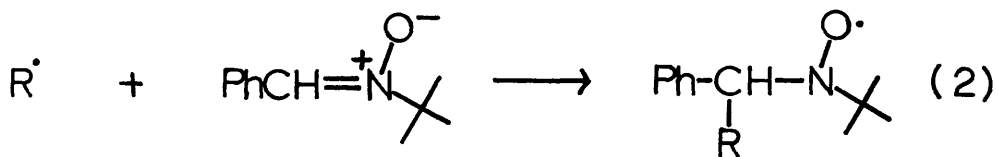
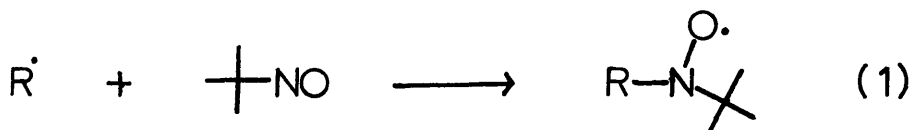

of the trapped radical which otherwise would have been too short-lived to be observed by e.p.r. It is generally assumed that the nitroxides formed in this way do not react further and compete with the nitroso compound or nitron for radicals  $\text{R}\cdot$ . However, the evidence presented in this thesis would seem to suggest that dimethylallyl radicals show greater reactivity towards a nitroxide than towards a nitroso compound. In this respect

Some results of Janzen and Blackburn<sup>23</sup> are worthy of comment. These workers, in a study of the thermal room temperature decomposition of phenyl-azotriphenylmethane in the presence of the 'spin-trap' phenyl-t-butyl nitron observed the e.p.r. spectrum of the triphenylmethyl radical (42) in addition to that of the phenyl 'spin-adduct' (43). On the basis of

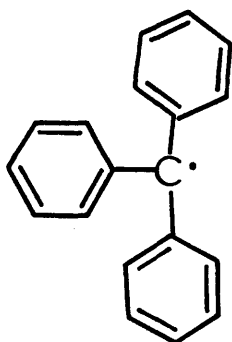

42

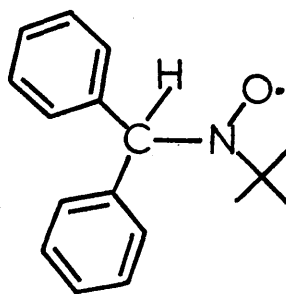

43

these and other observations, they concluded that 'apparently stable radicals are not trapped by phenyl-t-butyl nitron'. Moreover, according to Lagercrantz<sup>22</sup>, 'there is a general impression that small and very short lived radicals with a highly localized unpaired electron, such as methyl radicals, are more easily trapped than large and more stable species with spin density distributed over the molecule'. This of course is to be expected, since according to Hammond's postulate<sup>16</sup>, as the stability of the radical  $R^\cdot$  is increased, the transition state for the trapping reaction 1 or 2 will become more product-like and will therefore reflect product stability to a greater degree. Furthermore, since the commonly used spin-trapping agents namely, 2-nitroso-2-methyl-propane and phenyl-t-butyl nitron are relatively bulky, product

stability will be significantly affected by steric compression. Clearly therefore, there is little incentive for a large, relatively stable, radical to be trapped by a relatively bulky scavenger. Further confirmation of this arises by virtue of the known instability of trityl alkyl nitroxides as discussed earlier in this chapter. Thus, with respect to spin-trapping, it is important to note that the observed nitroxide radical may, in certain cases, result from trapping of the most reactive radical or radicals and not necessarily the predominant radical. In short, the greater the stability of the radical  $R^\cdot$  the more selective it is likely to be towards a radical scavenger. This is of course generally true and of the various methods available for determining relative reactivity, that based on selectivity offers an experimentally convenient method of comparing a wide range of radicals<sup>24</sup>. In this respect, the dimethylallyl radical appears to exhibit 100% selectivity in reacting exclusively with the nitroxide (3). This may, in part, be a result of there being less steric crowding in the transition state to forming the hydroxylamine (6) as opposed to that involved in forming the nitroxide (40).

In further attempts to characterise the mechanism of decomposition, the effect of solvent was studied. In three separate experiments, a sample of the pure nitroxide was allowed to decompose at room temperature as neat liquid and in benzene and isopropanol solutions. The progress of each reaction was monitored over 3 days by analytical t.l.c. As a result, it became apparent that, although all three decompositions yielded

the same products, there were some notable differences. First, the ratio of the epoxide (7) to the hydroxylamine (6) was greater when the nitroxide was allowed to decompose in solution (e.g. benzene) than when decomposition occurred as a neat liquid. This result merely reflects the fact that, in solution, there will be more dissolved oxygen per dimethylallyl radical than when decomposition occurs as a neat liquid. Secondly, decomposition in isopropanol was slower than in benzene. Possibly this is simply the result of greater solvation of the polar nitroxide relative to the less polar allyl radical and nitroso fragments. However, another relevant consideration is that the distribution of free electron density in nitroxides is solvent dependent<sup>5</sup>. Thus the g-factors and nitrogen hyperfine coupling constants in di-t-alkyl nitroxides depend on the solvent;  $a_N$  values being largest in polar solvents such as water and smallest in non-polar solvents such as benzene. This is believed to be a result of hydrogen bonding between the radical and the solvent (HX) altering the electronic distribution in favour of the polar form (45). Clearly there would be significant

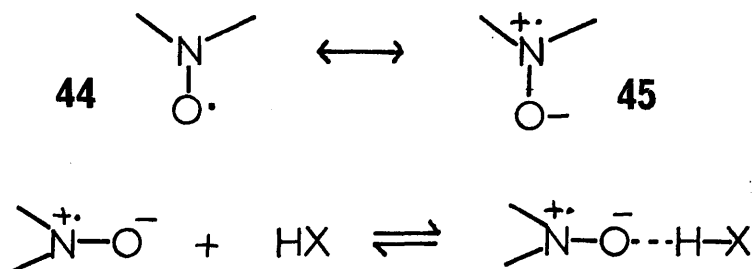

hydrogen bonding in an isopropanol solution of the nitroxide (3) but just how the distribution of free electron density could be related to the rate of decomposition is

unclear. A possible substantiation of the stabilizing effect of hydrogen bonding on the nitroxide (3) is provided by virtue of the fact that the nitroxide is much more stable in its oxidizing medium than outwith it. Thus the nitroxide (3) can be conveniently prepared by oxidation of the amine (4) by sodium tungstate/hydrogen peroxide over a period of two to three days whereas, once separated from the oxidizing medium, substantial decomposition occurs within a matter of hours. Oxidation with sodium tungstate/hydrogen peroxide takes place in an aqueous methanolic solution which would be strongly hydrogen bonding.

Further confirmation of the proposed mechanism as outlined on P.87 came from a study of the kinetics of decomposition of the nitroxide (3). Accurate kinetics were obtained by monitoring the intensity of the ~~n~~ absorption of the nitroxide at 460nm. For a  $10^{-1}$ M solution in carbon tetrachloride, decomposition was found to be first order with respect to the nitroxide (3): first order rate constant at 25°C,  $4.18 \times 10^{-5} \text{s}^{-1}$ ,  $t_{\frac{1}{2}}$ , 276 min. Similarly, the formation of 2-nitroso-2-methylpropane was followed (monitoring absorbance at 675 mn.) which was found to occur with a first order rate constant virtually identical to that of the nitroxide (3) ( $4.09 \times 10^{-5} \text{s}^{-1}$ ).

At this stage, having established the basic characteristics of the decomposition of the nitroxide (3), attention was turned to a consideration of possible repercussions of this instability in other nitroxides with similar  $\beta, \gamma$ -unsaturation. In particular, the cyclic nitroxides (46), (47) and (48), by analogy

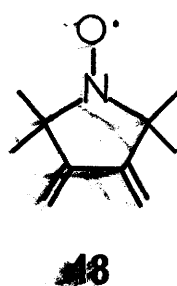
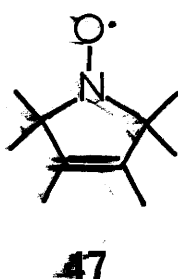
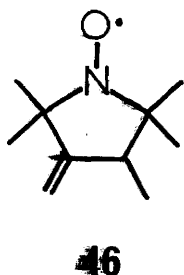

with the nitroxide (3), might be thermally labile since in each case, cleavage of a C-N bond would generate a nitroso moiety and an allylic radical. Specifically, the nitroxide (46), on thermolysis, might generate the intermediate

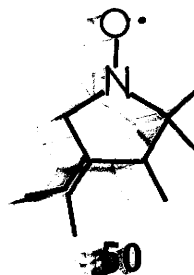
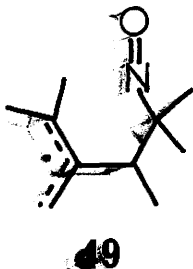
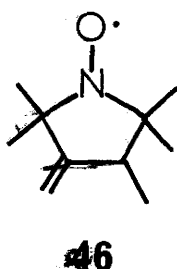

(49) which, if not trapped by another nitroxide radical, could conceivably ring-close by recombination of the nitroso moiety with the allylic radical via its more reactive primary position to form the isomeric nitroxide (50). While the nitroxides (47) and (48) might exhibit similar thermal instability, the prediction of their thermolysis products is somewhat more speculative. Nevertheless, in anticipation of some interesting thermal behaviour, the preparation of these cyclic nitroxides was undertaken.

The nitroxide (46) was prepared by oxidation of the corresponding amine (52) which is the product of the

reductive cyclisation of N-(1,1-dimethylallyl)-N-(1,1-dimethylpropargyl) amine (51)<sup>25</sup>. The nitroxide (47) was

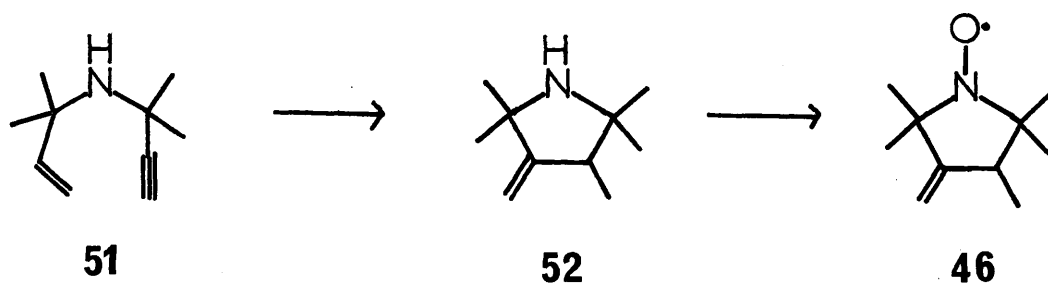

readily prepared by oxidation of 2,2,3,4,5,5-hexamethylpyrroline<sup>25</sup> and the diene-nitroxide (48) was prepared as described in Section I.

It was with considerable surprise that we observed that these cyclic nitroxides ably survived the thermolysis conditions to which they were subjected. Thus refluxing a solution of the nitroxide (46) in toluene for 17 hours resulted in no significant decomposition as evidenced by t.l.c. analysis. Similarly, no detectable decomposition resulted from refluxing a solution of the nitroxide (47) in toluene for 16.5 hours. When a solution of the diene-nitroxide (48) in benzene was refluxed for 15 hours, subsequent t.l.c. analysis revealed that a small amount of decomposition had taken place. Moreover, on refluxing the same nitroxide sample in toluene solution for a further 17 hours, t.l.c. analysis similarly indicated a minor (ca. 5%) amount of a polar product. However, this product may be a result of a possible Diels-Alder reaction of the diene-nitroxide (48) forming



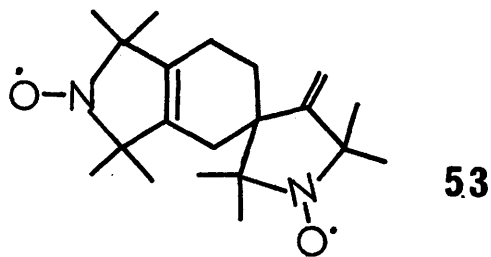

the bis-nitroxide (53).

It was thereby apparent that  $\beta,\gamma$ -unsaturation was not in itself sufficient to confer instability on the cyclic nitroxides and hence criteria other than this are also important when rationalising the relative instability of the nitroxide (3).

In particular, a cursory comparison of the nitroxide (3) with its cyclic analogue (46) reveals a structural

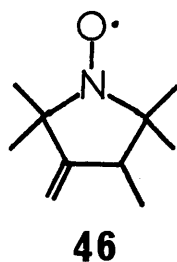
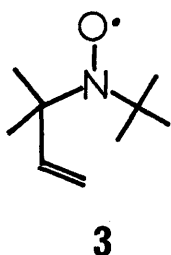

similarity which, at first sight, makes difficult a rationalisation of their vastly different thermal stabilities. However, on closer examination, one important difference becomes apparent ie. the acyclic nitroxide (3), by virtue of free rotation about the C-N bond, can adopt a conformation (54) which allows

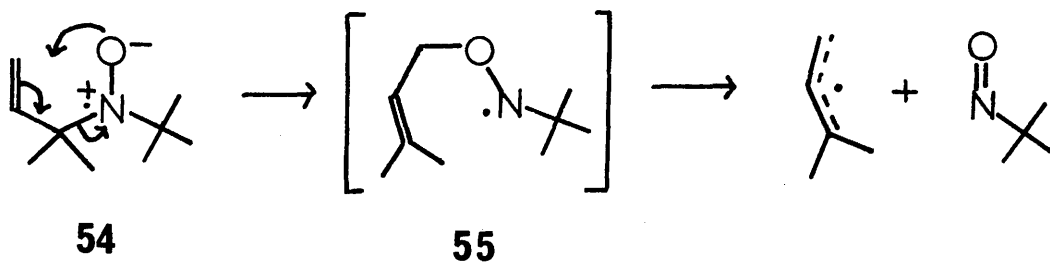

the double bond to interact with the oxygen atom of the nitroxide group. If, for convenience, the nitroxide is written in its dipolar form (54), then the system is, in principle, capable of undergoing a rearrangement formally analogous to a [2,3]-sigmatropic shift<sup>26</sup> to generate the N-alkoxy-N-alkylamino radical (55) which might fragment to the required nitroso and dimethylallyl radical components.

The [2,3]-sigmatropic rearrangement of ylids and related species viz. (56) to (57) is now a well established

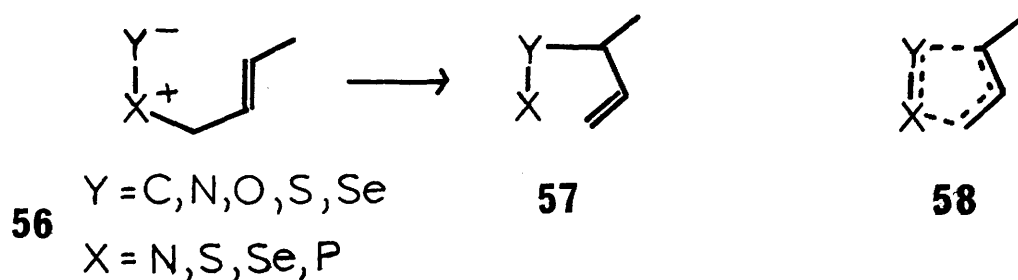

reaction type<sup>27,28</sup>. This concerted process formally involves the participation of six electrons and can be considered as an intramolecular  $S_N2^1$  reaction in which the suprafacial relationship<sup>29</sup> between breaking and forming bonds is readily achieved in the cyclic transition state (58). Numerous examples exist involving the rearrangement of a dimethylallyl group. For instance, the allylic diazine (59), formed by oxidation of the corresponding hydrazine, rearranges in high yield at ca. 0°C to the azo compound (60)<sup>30</sup>.

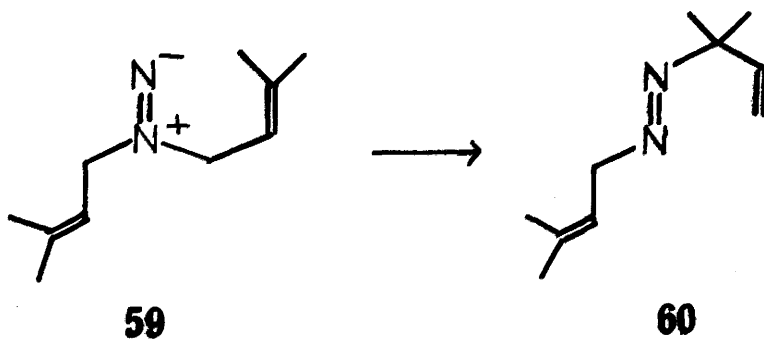

Another example involves the base-catalysed rearrangement of the allyl-propynyl ammonium cation (61) into the amine (62) (in about 90% yield) via the intermediate ylid (63)<sup>31</sup>. However, no examples of a [2,3]-sigmatropic

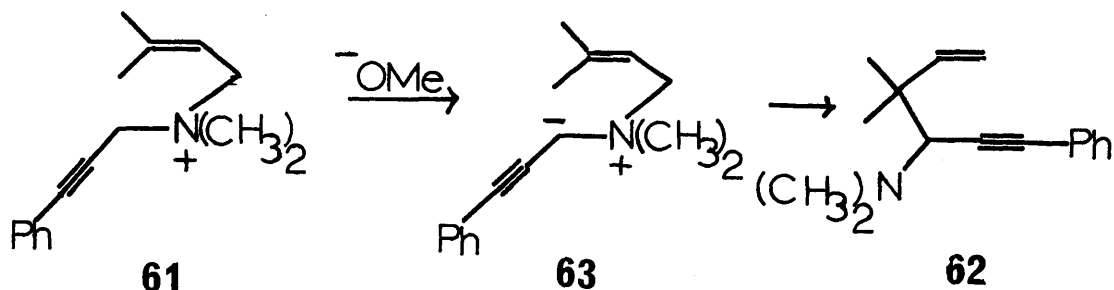

rearrangement involving a nitroxide have yet been reported in the literature.

Recently there has been some interest shown in N-alkoxyamino radicals such as (55). Spectroscopic evidence for the existence of such species was first reported in 1971 whereby the e.p.r. spectra of N-alkoxy-N-alkylamino radicals were recorded<sup>32</sup>. However, as a result of the use of 2,4,5-tri-*t*-butylnitrosobenzene (64) as a spin-trapping reagent, many more of these species have been observed by e.p.r. spectroscopy<sup>33,34</sup>. With this spin-trap, it is

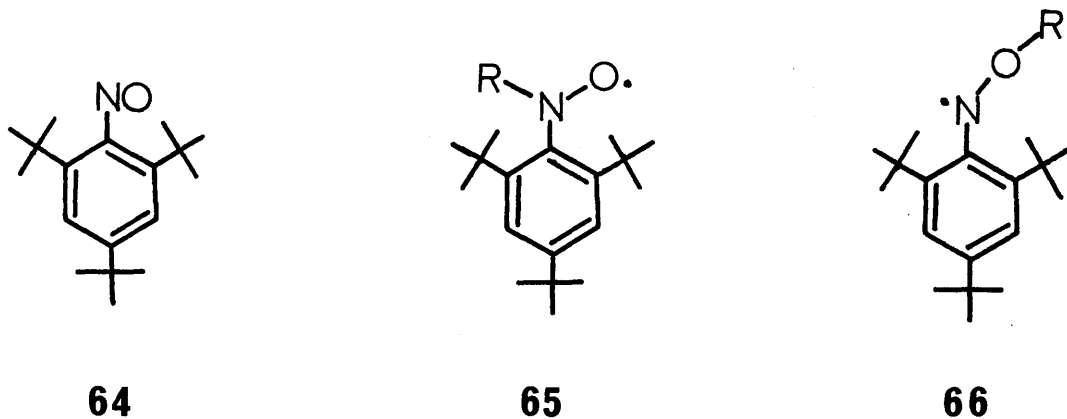

possible to deduce more information about the structure of

the trapped radical than with the more 'conventional' spin-traps, 2-nitroso-2-methylpropane and phenyl-*t*-butylnitron. This is a result of the fact that while 'small' radicals are trapped via the nitrogen atom of (64) producing nitroxides (65), sterically bulky radicals are trapped via the oxygen atom producing N-alkoxyanilino radicals (66). For example, 2,4,5-tri-*t*-butylnitroso-benzene (64) traps primary alkyl radicals exclusively via nitrogen, secondary alkyl radicals via nitrogen and oxygen and tertiary alkyl radicals exclusively via oxygen. The N-alkoxyanilino radicals (66) proved to be sufficiently stable to be detected by e.p.r. over several hours. Unfortunately, little is known about the chemistry of these radicals and the postulated fragmentation of (55) into 2-nitroso-2-methylpropane and a dimethylallyl radical is speculative at this stage. Nevertheless, some support is provided by an analogous cleavage which has been postulated to explain the fact that the e.p.r. spectrum attributable to the N-carboethoxy-N-alkylamino radical (67) disappears with time and is replaced by a

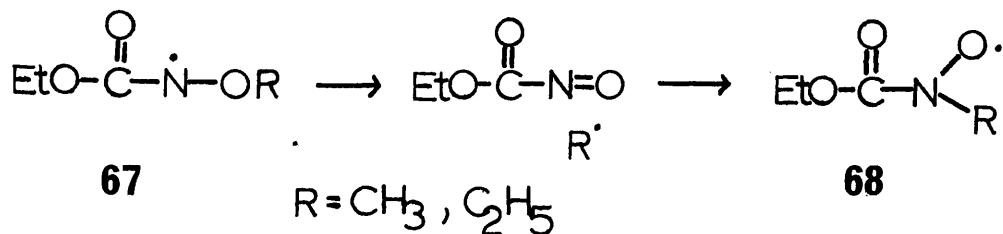

spectrum consistent with the nitroxide (68)<sup>35</sup>.

The primary appeal of invoking a [2,3]-sigmatropic shift in the decomposition of the nitroxide (3) is that it

Table 2

Temperature ( $^{\circ}\text{C}$ )	$k_{\text{obs.}}$ ( $\text{sec}^{-1}$ )
25.0	6.03, $6.21 \times 10^{-5}$
35.1	2.78, $2.72 \times 10^{-4}$
45.1	1.11, $1.12 \times 10^{-3}$
55.0	4.09, $4.05 \times 10^{-3}$

$$\Delta E^{\ddagger} = 27.23 \pm 0.06 \text{ Kcal mole}^{-1}$$

$$\Delta S^{\ddagger} = + 11.5 \pm 0.2 \text{ cal deg}^{-1}\text{mole}^{-1}$$

conveniently explains the vast difference in stability between this nitroxide and its cyclic counterpart (46). However, notwithstanding the aforementioned analogies, there existed no concrete evidence of the applicability of this mechanism to the decomposition of the nitroxide (3). In an attempt to remedy this situation, the decomposition of this nitroxide was followed at various temperatures and the entropy of activation ( $\Delta S^*$ ) calculated. It was hoped that a knowledge of the entropy of activation might shed some light on the question of whether the nitroxide (3) decomposed via a [2,3]-sigmatropic pathway (steps 1 and 2) or via a simple

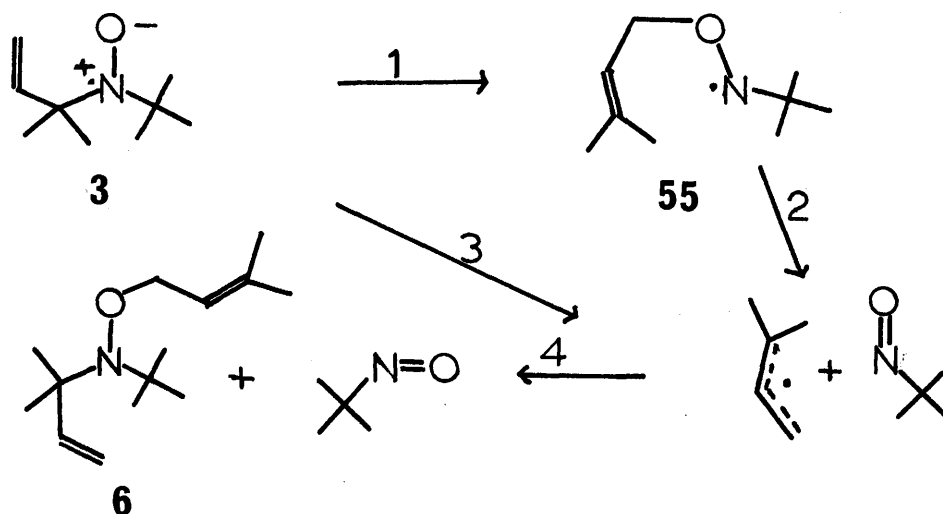

homolysis mechanism (step 3). Accurate rate data for each temperature were obtained by monitoring spectrophotometrically (450nm.) solutions of the nitroxide (3) (ca.  $10^{-1}$ M) in methylcyclohexane. The temperature was thermostatically controlled to within 0.2 deg. and at each temperature, two separate runs were made to check reproducibility. Listed in Table 2 are the observed

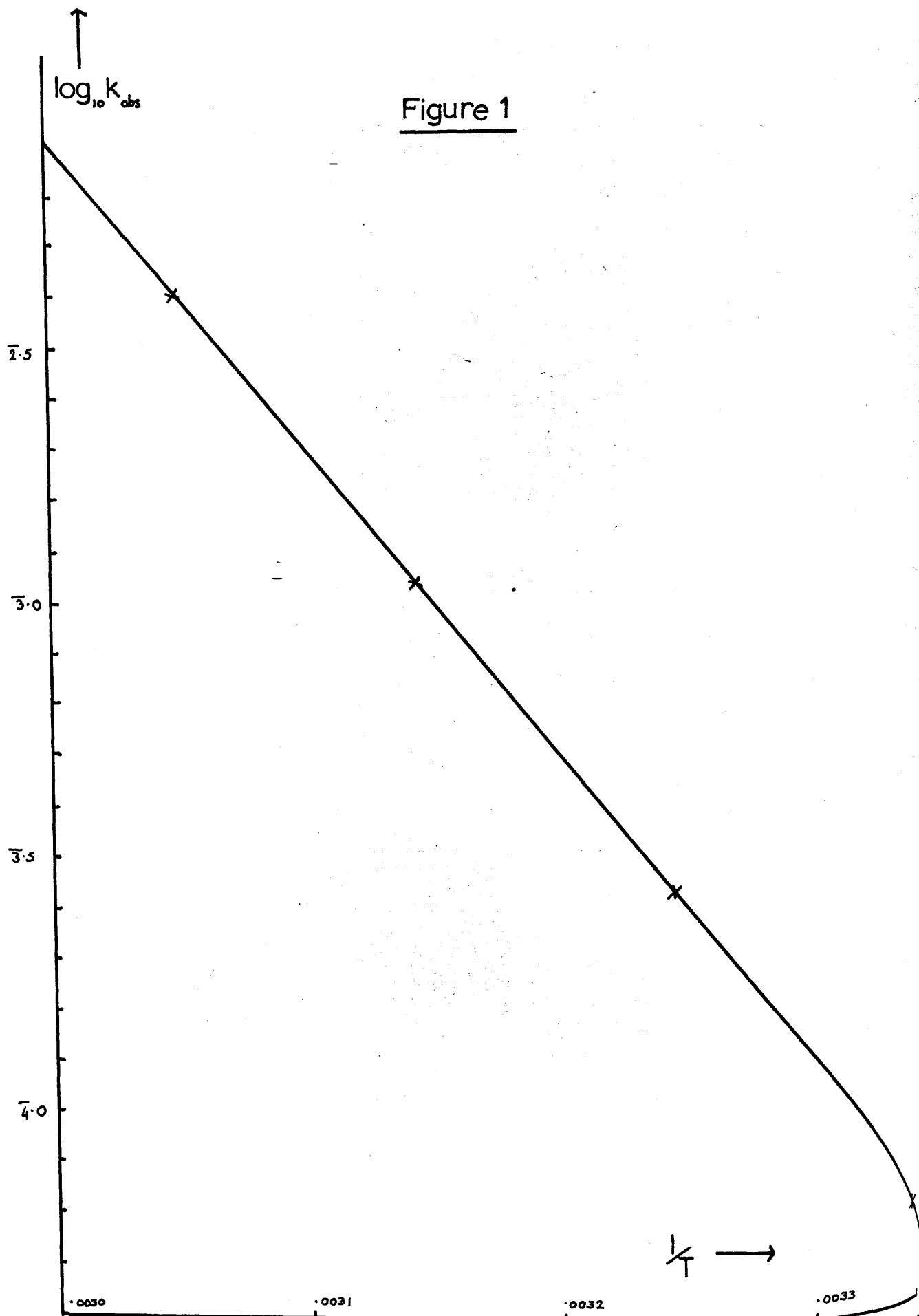
Figure 1

rate constants calculated for each temperature. These results are also displayed graphically (Fig. 1) and show the relationship between  $\text{Log } K_{\text{obs.}}$  and  $1/T$  as required by the equation :

$$K = \frac{k_B T}{h} \cdot e^{\frac{\Delta S^\ddagger}{R}} \cdot e^{-\frac{E_a}{RT}}$$

On the basis of these results, the energy and entropy of activation were calculated:

$$\Delta E^\ddagger = 27.23 \pm 0.06 \text{ Kcal mole}^{-1}$$

$$\Delta S^\ddagger = + 11.5 \pm 0.2 \text{ cal deg}^{-1} \text{ mole}^{-1}$$

This value of +11.5 entropy units (e.u.) does not allow an unambiguous rationalisation, principally because, in the case of the [2,3]-sigmatropic pathway, we are not in a position to know which step would be rate-determining. In the absence of any quantitative data for the relative rates of steps 1 and 2, either the rearrangement (step 1) or the fragmentation of the N-alkoxy-N-alkyl-amino radical (step 2) could be rate-determining. The combination of a dimethylallyl radical with the nitroxide (step 4) is expected to be fast so that in simple homolysis mechanism, step 3 would be rate-determining. The [2,3]-sigmatropic rearrangement (step 1), since it involves an ordered cyclic transition state, would be expected to occur with a negative or nearly zero entropy of activation<sup>36</sup>. The fragmentation steps (2 and 3) on the other hand would be expected to occur with a positive entropy of activation. Clearly therefore, the



finding of a significantly positive entropy of activation does not in itself distinguish between the simple homolysis mechanism (step 3) and the [2,3]-sigmatropic shift mechanism in which the fragmentation (step 2) is rate-determining.

If indeed the [2,3]-sigmatropic rearrangement does apply, then chemical evidence would suggest that the N-alkoxy-N-alkylamino radical (55) is short-lived. For instance, no signal corresponding to such a species is observed in the e.p.r. spectrum of the nitroxide (3) at room temperature. Moreover, if the radical (55) was relatively long-lived, under the conditions of decomposition of the nitroxide (3), one might expect that it would trap a dimethylallyl radical to form

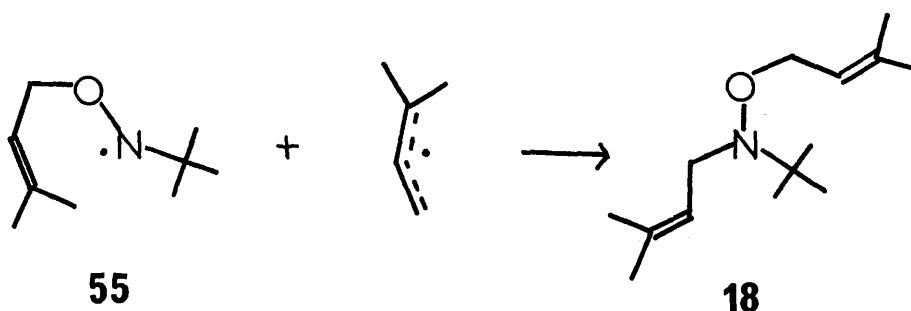

the hydroxylamine (18). There is no evidence to suggest that this hydroxylamine is formed during the room temperature decomposition of the nitroxide (3).

Neither is the hydroxylamine (69) formed when the nitroxide (3) is allowed to decompose at room

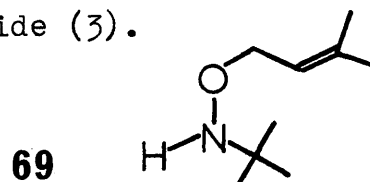

temperature in isopropanol; a solvent which is noted as a relatively reactive source of  $\dot{H}$ . This evidence might

tentatively suggest that the rearrangement (step 1) would be rate-determining which, in view of the positive entropy of activation found, would mean that the nitroxide (3) decomposed via a simple homolysis mechanism.

However, it must be stressed that this conclusion is only tentatively based on qualitative evidence and that firm mechanistic conclusions would require a knowledge of whether or not the N-alkoxy-N-alkylamino radical (55) fragments to a dimethylallyl radical and 2-nitroso-2-methylpropane and if so, at what rate.

Another possible explanation of the difference in stability of the nitroxides (3) and (46) is again related to rotational constraints present in the cyclic system as opposed to the acyclic system. As a result of free rotation, the nitroxide (3) can adopt conformations in which the  $\pi$ -orbitals of the double bond are aligned with the C-N bond. Therefore as bond breaking

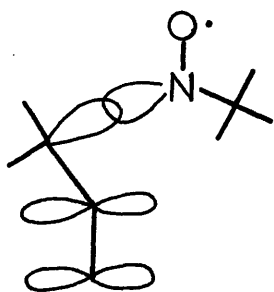

3

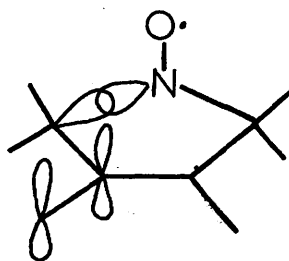

46

commences and the C-N bond lengthens, the developing p-orbital on carbon can interact with the  $\pi$ -orbitals of the

double bond thereby stabilizing the system. This stabilizing condition could extend along the entire reaction co-ordinate until finally C-N bond breaking is complete. In the case of the nitroxide (46), on the other hand, the cyclic structure demands that the C-N bond is orthogonal to the  $\pi$ -orbitals of the double bond. Therefore, if one imagines C-N bond cleavage, as the C-N bond lengthens, the developing p-orbital on carbon will initially be orthogonal to the  $\pi$ -system of the double bond. Presumably as bond breaking continues, the developing p-orbital will gradually come into conjugation with the  $\pi$ -system of the double bond as a result of rotation about the C-C single bond. It is difficult to predict to what extent breaking of the C-N bond must occur before C-C single bond rotation can bring about overlap of the p-orbital with the double bond since this will presumably depend upon the relative advantage of stabilization by conjugation over weakening of the C-N bond by C-C single bond rotation at any particular point on the reaction co-ordinate. In short, the double bond of the acyclic nitroxide (3) could provide anchimeric assistance<sup>37</sup> to carbon nitrogen bond cleavage whereas the double bond of the cyclic nitroxide (46) could not. Such anchimeric assistance would lower the energy of the transition state for the fragmentation of (3) and hence provide an explanation of the difference in stability between the nitroxides (3) and (46). Somewhat analogous considerations of stereoelectronic control have previously been proposed to explain the course of certain radical reactions. Thus while the  $3\alpha$ , 5-cholestan-6-yl

radical (70) rearranges to the radical

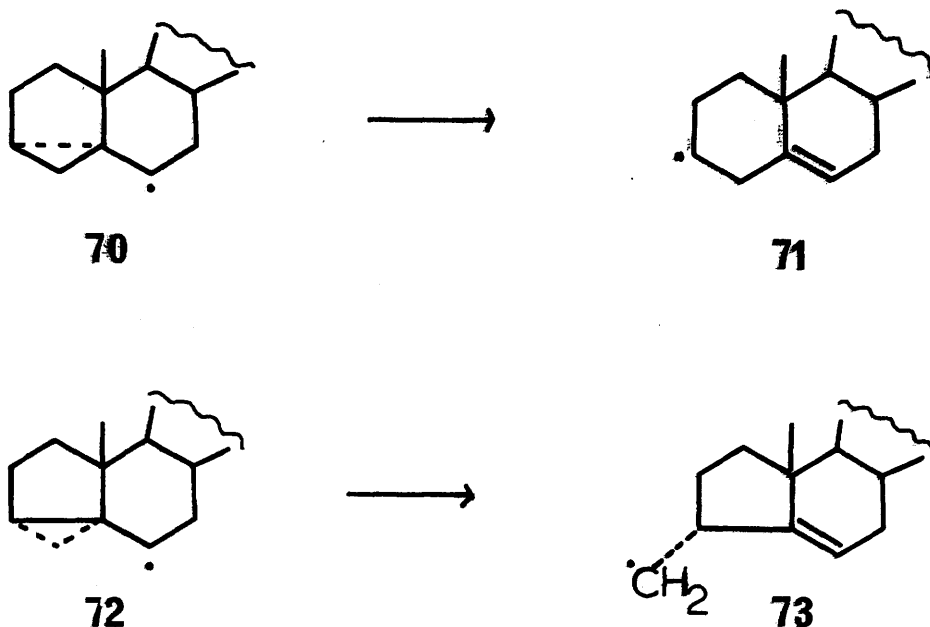

(71)<sup>38</sup>, the  $3\beta$ , 5-cholestan-6-yl radical (72) rearranges to (73)<sup>39</sup>. This is rationalised in terms of overlap of the p-orbital with an appropriate  $\sigma$ -bond since, in each case, the  $\sigma$ -bond which suffers fission is that which lies closest to the plane of the p-orbital at C-6<sup>39</sup>.

One further structural difference which is worthy of consideration is simply that whereas the acyclic nitroxide (3) decomposes into two fragments, C-N bond fission of the cyclic nitroxide (46) would yield one fragment. Therefore, entropy might be a relevant factor in considering the relative stabilities of these two compounds. As stated previously, the significantly positive value found for  $\Delta S^*$  (+11.5 e.u.) means that the rate determining step for thermolysis of the nitroxide (3) must be a fragmentation (steps 2 or 3) of one species into two. It can be calculated that, for a reaction step involving the generation of two species from one in solution, the gain

in translational and rotational entropy is of the order of 40-50 e.u.<sup>40</sup>. In crude terms, the value of +11.5 e.u. for  $\Delta S^\ddagger$  means that the transition state for the fragmentation step (2 or 3) occurs about one quarter of the way along the reaction co-ordinate. Therefore, although the entropy factor will be important, it cannot in itself account for the observed difference in stability of the two nitroxides.

Finally, one probably relevant factor, which is unfortunately difficult to quantify, is the influence of steric crowding on the relative stabilities of the two nitroxides (3) and (46). By reference to the work of Janzen *et. al.*<sup>12</sup>, it was established earlier in this discussion that the instability of the nitroxide (3) probably reflected to a considerable extent the steric crowding around nitrogen. Recourse to molecular models reveals that the steric crowding around nitrogen is less severe in the cyclic nitroxide (46) than in its acyclic counterpart but it is extremely difficult to translate this difference into quantitative data. However, this intractability should not be allowed to diminish the possible importance of this factor in accounting for the relative stabilities of the two nitroxides. Qualitatively, it may be concluded that relief of steric compression will assume greater relevance in the decomposition of (3) than in the hypothetical decomposition of (46).

Having now discussed in some detail the possible rationalisations of the relative stabilities of the cyclic and acyclic nitroxides, it is unfortunate that no firm mechanistic conclusions can be drawn at this time. While it is reasonable to assert that both steric and entropic

factors will be relevant, the extent to which they account for the difference in stability is unclear. The question of a [2,3]-sigmatropic rearrangement versus anchimerically assisted homolytic fission must await a study of the chemistry and kinetics of the N-alkoxy-N-alkylamino radical (55). Evidence of the applicability of the latter mechanism might be found by preparing the nitroxides (74) and (75) and comparing their thermal stabilities to that of the

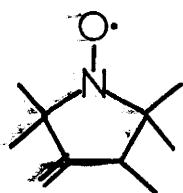

46

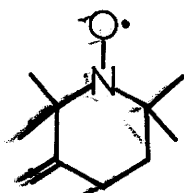

74

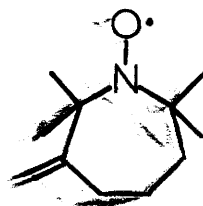

75

nitroxide (46). From a study of molecular models, it is apparent that, on increasing the ring size through six to seven, the average angle which the C-N bond makes with the  $\pi$ -orbitals of the double bond decreases from the  $90^\circ$  imposed by the rigid pyrrolidine structure of (46). Therefore, on increasing ring size, the extent to which the double bond could anchimerically assist C-N bond cleavage would increase (at least up to medium sized rings). Hence, if such mechanistic considerations did apply, then the thermal stability of the nitroxides should decrease in the order (46), (74), (75).

Notwithstanding the aforementioned mechanistic uncertainties, it is clear that the decomposition of the

nitroxide radical (3) reflects, to some degree, the stability of the dimethylallyl radical. The relation between the structure and reactivity of a free radical has for many years been the subject of intense interest and speculation. In relatively recent years, however, particularly as a result of improved methods of generation and observation of free radicals, some of the complexities and subtleties inherent in this subject have come to be appreciated<sup>24, 41</sup>. One aspect of this subject which has been of interest generally and which is relevant to this discussion, is the effect on the stability of alkyl radicals of adjacent unsaturated groups, viz. olefinic and acetylenic groups<sup>15, 42</sup> and the cyclopropyl group<sup>43</sup>. Particular interest has been shown in the relative abilities of a double and a triple bond to stabilize an adjacent radical centre. Thus in a study of the thermolysis of  $\beta,\gamma$ -olefinic and  $\beta,\gamma$ -acetylenic peresters, Martin and Sanders<sup>42</sup> concluded that the 2-buten-1-yl radical (76) was about 4 Kcal/mole more stable than the 2-butyne-1-yl radical (77). However, a different finding

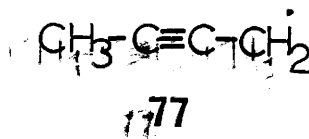
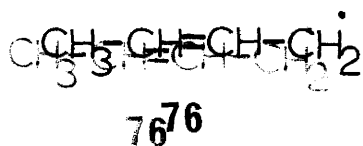

was reported by Engel and Bishop<sup>15</sup> who, from a study of the relative rates of thermolysis of the allylic azo compound (35) and the propargylic azo compound (78), concluded

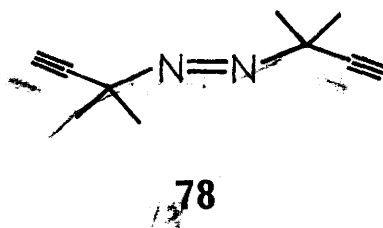
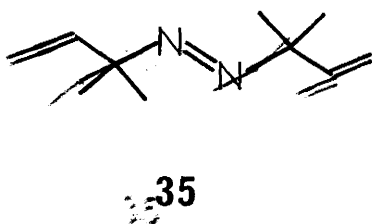

that double and triple bonds differ relatively little in their ability to stabilize an adjacent radical site. We considered that some light might be thrown on this controversy by a comparative study of the stabilities of the olefinic nitroxide (3) and the corresponding acetylenic nitroxide (79). If it was established that these two nitroxides

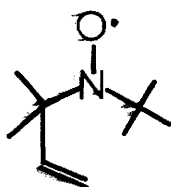

3

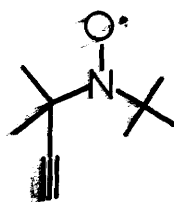

79

decomposed by similar mechanisms and particularly with rate-determining C-N bond fission, then it may be possible to relate the relative stabilities of the nitroxides (3) and (79) to the relative stabilities of the dimethylallyl and dimethylpropargyl radicals. However, it must be stressed that, as Rüchardt has pointed out<sup>24</sup>, this can be a severely oversimplified approach. The position of the transition state along the reaction co-ordinate and special steric, stereo-electronic and polar effects can often be significant and may profoundly affect the validity of the conclusions. Nevertheless, it was considered that the acetylenic nitroxide (79) did merit some attention and it was duly prepared by oxidation of the corresponding acetylenic amine. The nitroxide (79), previously reported by Russian workers<sup>44</sup> was isolated as yellow needles m.p. 64°C.

The acetylenic nitroxide did indeed prove to be unstable and its decomposition in solution at room



temperature over a period of 24 hours gave rise to a complex array of products as evidenced by t.l.c. analysis. It is no exaggeration to state that this complexity of decomposition was to prove to be a distinguishing feature of the acetylenic nitroxide (79). As in the case of the olefinic nitroxide (3), problems were encountered in the purification of this nitroxide. However, being a solid at room temperature, it was possible to obtain pure samples by careful recrystallisation from ice-cold petroleum ether (60-80).

Initial studies were concerned with establishing the nature of the principal decomposition products therefore the nitroxide (79) was subjected to thermolysis which resulted in its rapid decomposition. In a typical thermolysis, a solution of the nitroxide in benzene was heated in an oil bath to about 80°C. After approximately 4 minutes, the initially red solution rapidly turned to emerald green and a volatile blue compound was seen to collect around the base of the condenser. On continued heating, the green colour faded somewhat and after a total of ca. 8 minutes heating the resultant yellow/green solution was allowed to cool. T.l.c. examination revealed the formation of at least six major products with total consumption of the nitroxide. It was expected that the acetylenic nitroxide might decompose in a manner analogous to its allylic counterpart viz. by initial cleavage to 2-nitroso-2-methylpropane and a dimethylpropargyl radical followed by

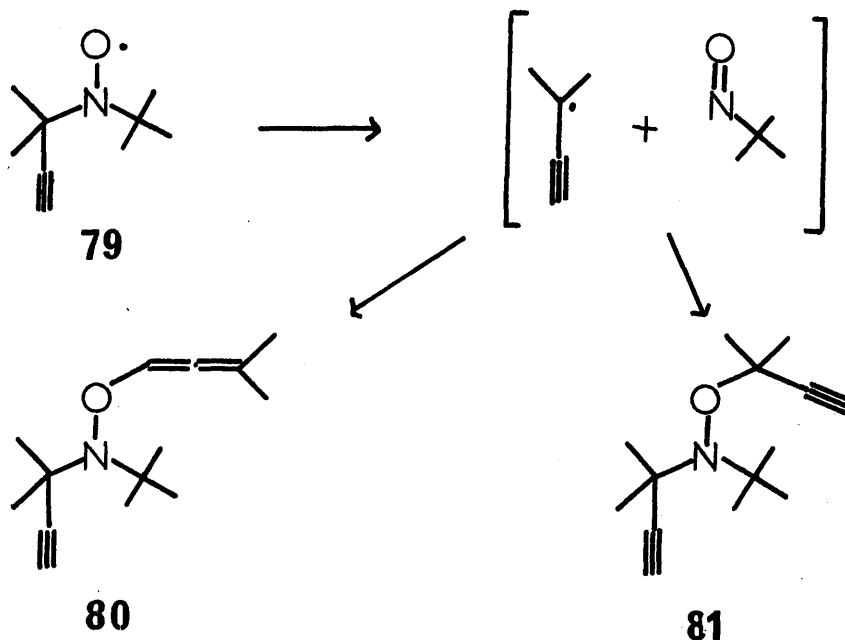

trapping of the propargyl radical to form one or other or both of the trialkylhydroxylamines (80) and (81).

However, as a result of the isolation of but two of the decomposition products, Nature was about to demonstrate the weakness of this analogy.

One of these compounds, a minor non-polar component was isolated as a colourless oil which proved to be unstable. Characterisation of this compound (for convenience called product A) proved difficult in view of its instability at ambient temperatures. The i.r. spectrum of this compound indicated the presence of a terminal acetylene group ( $3300 \text{ cm.}^{-1}$ ) and a carbonyl group ( $1725 \text{ cm.}^{-1}$ ). Although the n.m.r. spectrum exhibited an *N*-*t*-butyl group ( $\tau = 8.68$ ), a vinylic methyl group ( $\tau = 8.25$ ) and an acetylenic hydrogen ( $\tau = 7.65$ ), it was not possible to unequivocally assign all the peaks in the spectrum. The highest peak in the high resolution

Figure 2

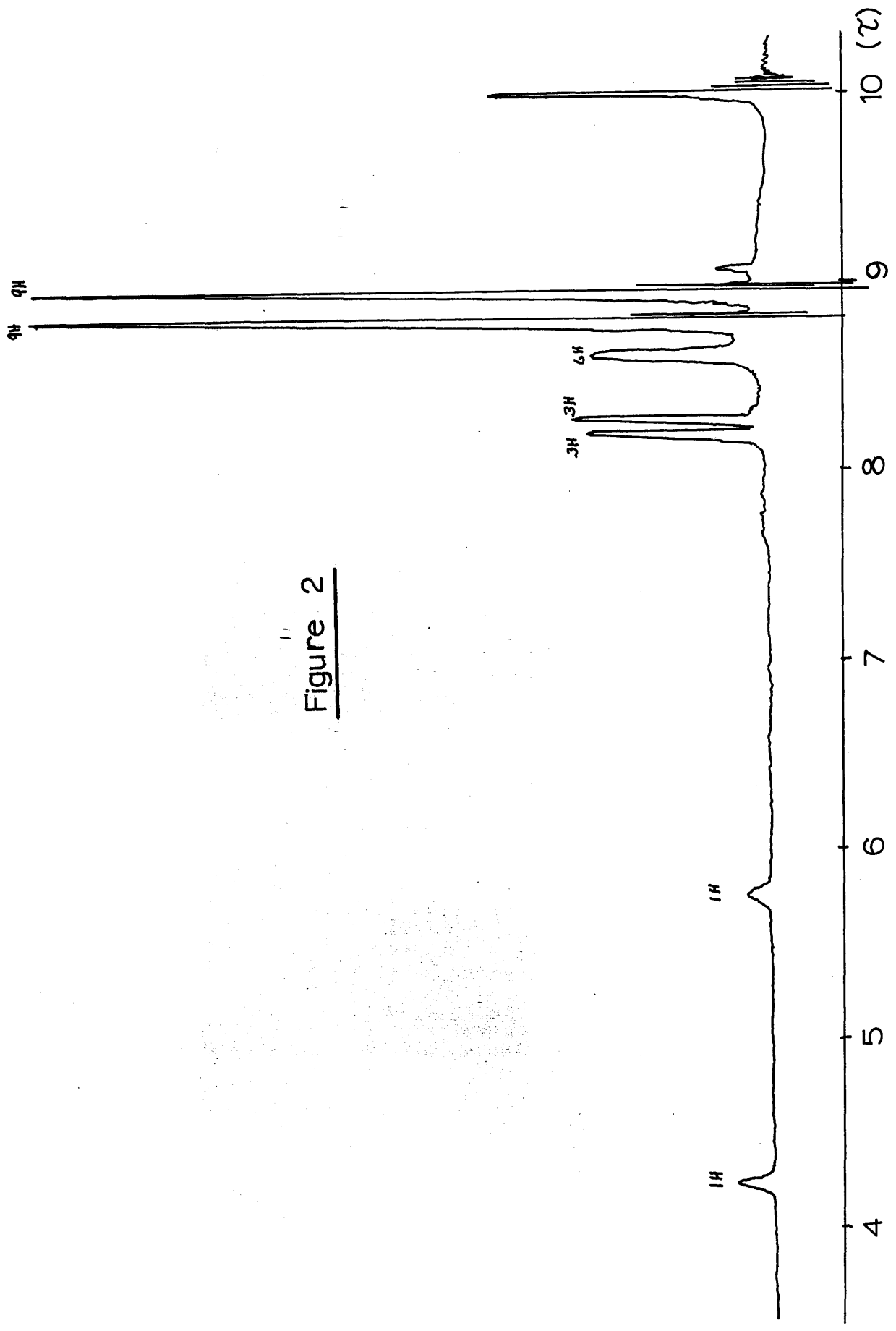

mass spectrum corresponded to a molecular formula of  $C_{12}H_{21}NO$  but it is not clear whether this represents the molecular ion or a fragment ion. The structure of this compound remains a mystery.

More attention was focussed on the second of the two isolated components. This, the major, more polar, component (for convenience called product B) was isolated in ca. 40% yield as a colourless crystalline solid. Spectroscopic analysis showed that this compound did not correspond to the two possible hydroxylamines (80) and (81). Apart from revealing the presence of a carbonyl group ( $1713\text{cm}^{-1}$ ) the i.r. spectrum was largely uninformative. The n.m.r. spectrum (see Fig. 2) was deceptively simple and the lack of significant coupling was subsequently to prove to be a major stumbling-block in attempting to relate the various proton resonances into some form of molecular framework. Nevertheless, n.m.r. did confirm the presence of two N-t-butyl groups ( $\tau = 8.96$  and  $8.80$ ) and two vinylic methyl groups ( $\tau = 8.31$  and  $8.22$ ). The resonances at  $\tau = 8.66$  and  $8.62$  were, by analogy with previously encountered trialkylhydroxylamines, tentatively assigned as being due to gem-dimethyl groups adjacent to nitrogen or oxygen viz.  $(\text{CH}_3)_2\text{-C-N(O)}$ , while the slightly broadened singlets at  $\tau = 5.82$  and  $4.31$  were notably uncharacteristic of any structure previously encountered or envisaged. Spin-decoupling of a 100MHz. n.m.r. spectrum of this compound showed that the only coupling was between the vinylic methyls ( $\tau = 8.31$  and  $8.22$ ) and the peak at  $\tau = 5.82$  with a small J value of ca. 0.5Hz. The high resolution mass spectrum indicated a molecular ion

corresponding to the formula  $C_{18}H_{32}N_2O_3$  and despite the presence of some metastable peaks, further analysis of the fragmentation pattern did not prove informative.

Having collected this data, considerable effort was made in attempting to piece together this jig-saw of information into a viable structure. There were, however, several factors mitigating against this effort namely, as previously stated, the dearth of significant coupling in the n.m.r., the presence of some unfamiliar and unenvisaged resonances ( $\tau = 5.82$  and  $4.31$ ) and the unexpected molecular formula,  $C_{18}H_{32}N_2O_3$  which corresponded to a dimer of the nitroxide (79) plus oxygen automatically posed the question of the source of this 'extra' atom. Was this oxygen atom provided by oxygen from the atmosphere or by some disproportionation of the nitroxide and by what mechanism? A consideration of the molecular formula indicated that the structure had four double bond equivalents. Two of these were accounted for by the presence of a carbonyl group and a double bond while the remaining two suggested a bicyclic structure for product B. What chemical evidence there was at this juncture suggested that decomposition of the acetylenic nitroxide did, at some stage, involve cleavage into dimethylpropargyl radicals and 2-nitroso-2-methylpropane as indicated by the formation of a volatile blue material during thermolysis. However, as distinct from the decomposition of the olefinic nitroxide (3), the subsequent disappearance of the blue colour, even when the decomposition was conducted in a sealed tube, indicated that the nitroso compound was consumed by further

reaction. Clearly, we were dealing with a much more complex system than in the case of the decomposition of the allyl nitroxide (3) probably in part a result of the fact that trapping of the dimethylpropargyl radical via



the tail position would generate the reactive allenic function. Unfortunately, virtually no documentation exists concerning the reactivity of dimethylpropargyl/allenyl radicals in the presence of the nitroxide and nitroso moieties thus rendering a priori mechanistic predictions exceedingly speculative.

In view of the problems related to the analysis of the spectroscopic data of these products and, in particular, of the major product B, a number of experiments were conducted in an attempt to gain some foothold into this mountain of structural and mechanistic uncertainty. Since 2-nitroso-2-methylpropane appeared to be consumed during thermolysis, attempts were made to remove this compound as it was formed in the hope that the final product mixture would be simplified. Thus a solution of the nitroxide (79) in methylcyclohexane was rapidly heated (80-90°C for 35 minutes) in a micro-distillation unit. While some nitroso compound did distil across, t.l.c. examination of the residue revealed the same mixture of products in the same proportions as had been previously observed. In a similar thermolysis conducted with the exclusion of oxygen, a solution of the acetylenic nitroxide

in benzene was thoroughly degassed by a stream of oxygen-free nitrogen prior to being heated at ca. 80°C for 5 minutes. Subsequent t.l.c. analysis again revealed that the same mixture of products were formed in similar relative amounts. Therefore the 'extra' oxygen atom in the product B must arise via some form of disproportionation reaction involving the nitroxide or nitroso group. Similar products and product ratios resulted from the room temperature decomposition of a solution of the nitroxide in benzene over a period of 4 days so that the mechanism of decomposition was apparently temperature independent within the range 20-100°C.

From a consideration of what was known about the gross structures of the two isolated products A and B viz. the presence of two N-t-butyl groups in B and one in A, it was considered possible that the major product B might be formed by reaction of A with 2-nitroso-2-methylpropane. To test this possibility, a solution of the product A and 2-nitroso-2-methylpropane in benzene was heated in a sealed tube at 90°C for 6 minutes. After this time, the blue colour of the nitroso monomer still persisted and analytical t.l.c. indicated the total absence of product B.

A more fruitful approach to the structural elucidation of the product B proved to be via its reduction. As previously stated, one of the major barriers to a solution of the n.m.r. spectrum was the lack of significant coupling and, in view of the presence of reducible functions in the molecule (viz. carbonyl and olefinic groups), it was considered that reduction of these functions with the introduction of more hydrogen atoms into the system could

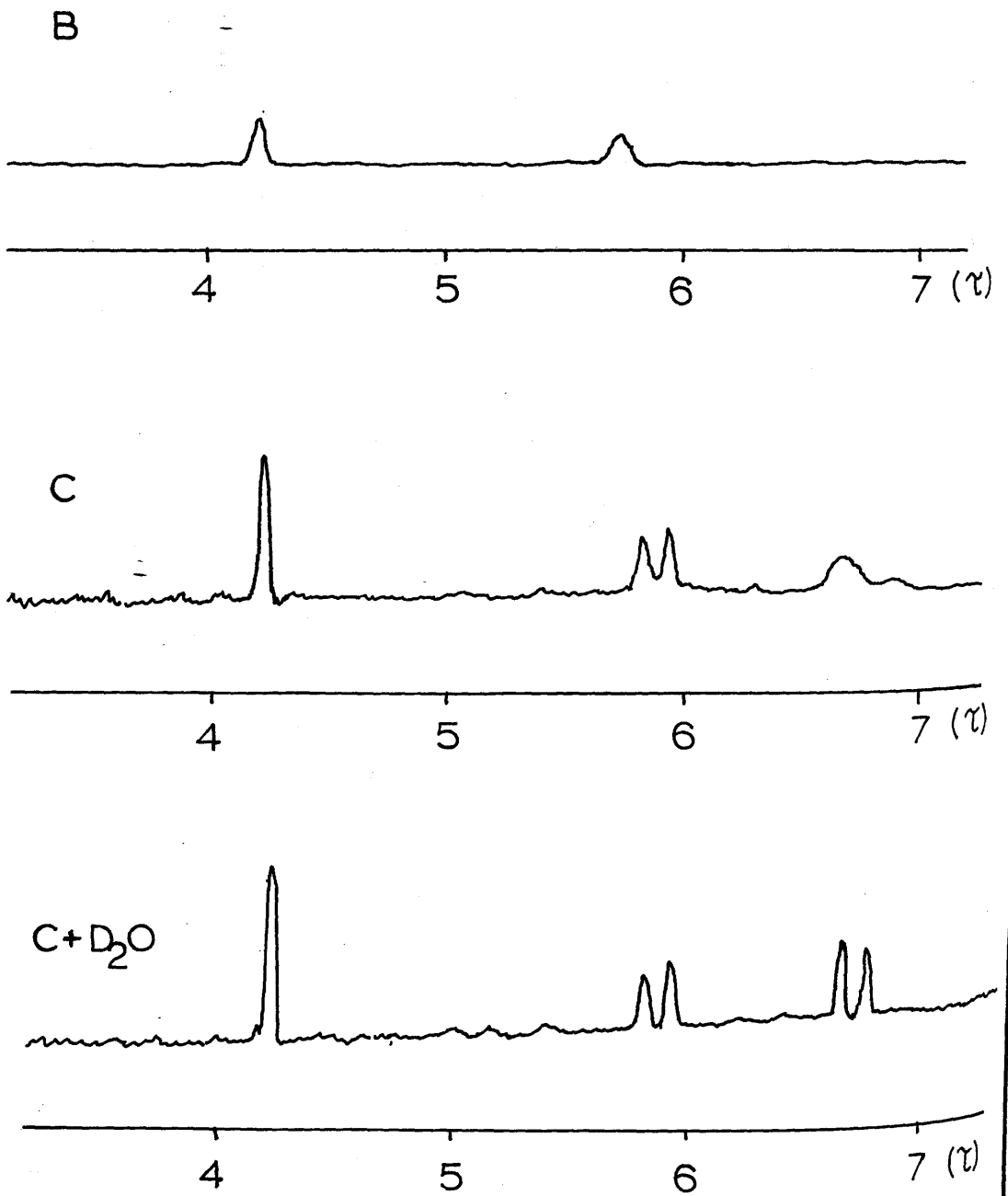

Figure 3



provide useful coupling in the n.m.r. spectra of the products. Such coupling would be advantageous in attempting to relate the various resonances in terms of a molecular structure. The carbonyl stretching frequency of B ( $1713\text{cm}^{-1}$ .) suggested that it was ketonic and therefore would readily undergo reduction to the corresponding alcohol (s) with lithium aluminium hydride. Indeed, reduction of B with this reagent did proceed smoothly at  $0^{\circ}\text{C}$  yielding two products.

The i.r. spectrum of the less polar of these (product C), exhibited a broad concentration-independent absorption at around  $3360\text{cm}^{-1}$ , was devoid of any carbonyl absorption and was thus consistent with an intramolecularly hydrogen bonded alcohol. The n.m.r. spectrum was also consistent with an alcohol and the introduction of two more hydrogens into the molecule was especially informative. In particular this compound gave rise to a broad doublet centred on  $\tau = 5.90$  ( $J=7\text{Hz.}$ ) and a very broad singlet centred on  $\tau = 6.67$ . On exchange with  $\text{D}_2\text{O}$ , the broad singlet ( $\tau = 6.67$ ) became a reasonably sharp doublet ( $J=7\text{Hz.}$ ) while the doublet at  $\tau = 5.90$  also became sharper. Portions of these spectra and their relationship to product B are shown in Fig.3. This data provided a clear indication that the resonance at  $\tau = 5.82$  resulted from a proton adjacent to the ketone function of B viz.  $-\text{CO}-\text{CH}$ ). The n.m.r. of the product C exhibits coupling between the proton at  $\tau = 5.82$  and the methine proton now at  $\tau = 6.67$  the latter signal being broadened by coupling to the hydroxyl proton. On addition of  $\text{D}_2\text{O}$ , rapid exchange of the hydroxyl proton takes place eliminating the coupling between it and the methine proton at  $\tau = 6.67$

which becomes a reasonably sharp doublet ( $J=7\text{Hz.}$ ).

Corroboration of the ketonic nature of B is provided by the chemical shift of the proton introduced on reduction ( $\tau=6.67$ ) which indicates that the carbonyl group is flanked by saturated carbon residues. Moreover, the fact that no other coupling was introduced on reduction of this ketone indicates that its other adjacent sites are blocked, probably by the gem-dimethyl group ( $\tau=8.66, 8.62$ ) as outlined in the partial structure of B (82).

Group X must be oxygen or nitrogen to satisfy the chemical

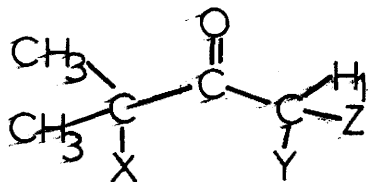

82

shift and lack of coupling of the gem-dimethyl protons while the groups Y and/or Z must be electron withdrawing in view of the deshielding of the proton  $H_1$  ( $\tau=5.81$ ).

Mass spectral data confirmed that two hydrogens had been added on reduction of product B with lithium aluminium hydride.

The other, more polar, product D of hydride reduction of B had spectral characteristics consistent with an alcohol isomeric with C. The i.r. spectrum showed a weak absorption at around  $3600\text{cm.}^{-1}$  and was devoid of any carbonyl absorption. The n.m.r. spectrum displayed a similar picture to the previous case although the chemical shift of the newly introduced methine proton was

different ( $\tau = 6.28$ ) and its coupling constant to the proton at  $\tau = 6.07$  (corresponding to  $\tau = 5.90$  in C) was much smaller (J ca. 1Hz.).

Thus the formation of these two isomeric alcohols, presumably formed by two directions of attack of hydride ion on what must be a cyclic ketone, proved to be instrumental in elucidating the structure of the immediate environment of the carbonyl function.

In the hope that the same approach might prove useful in the elucidation of the structural environment of the double bond, the compound B was subjected to catalytic hydrogenation. Hydrogenation of a solution of B in methanol at atmospheric pressure and room temperature with 5% palladium on charcoal as catalyst proved ineffective. Neither did 10% palladium on charcoal catalyse hydrogenation under similar conditions. Hydrogenation of B did proceed using Ra ney nickel as the catalyst and after 4 hours two products were isolated by preparative t.l.c. However, the n.m.r. spectra of these compounds indicated that they bore no useful structural resemblance to the product B. As a result, the nature of the structural environment of the double bond remained largely unresolved. However, the presence of the small coupling between the vinylic methyls and the resonance at  $\tau = 5.82$  in the n.m.r. spectrum of B suggested a homoallylic relationship of these protons as described by the partial structure (83). The absence of further coupling to the proton at  $\tau = 5.82$

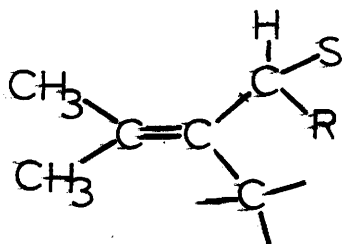
**83**

required the remaining olefinic position to be substituted, probably by carbon since there was no indication of the presence of enolic or enamine-type structures from the i.r. spectrum. It was believed that this carbon would be fully substituted since no other protons exhibited homoallylic coupling to the vinylic methyls.

Considering structures (82) and (83) together, a partial structure (84) can be drawn in which the groups X

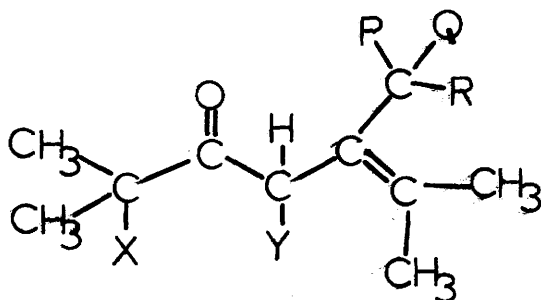
**84**

and Y are electron withdrawing (probably nitrogen or oxygen) while the nature of the groups P, Q and R is unknown except that none of them are hydrogen.

Unfortunately, it was found not possible to satisfactorily assign the proton at  $\tau = 4.31$  in terms of this partial structure. In principle, all that was required was the combination of the partial structure (84) with two

t-butyl-N-O fragments into a bicyclic framework. On paper, this exercise generated a number of possible structures whose genesis from the acetylenic nitroxide (79) seemed obscure and whose structural elucidation by chemical means did not appear to be a straightforward task.

In view of apparent complexity, it was considered at this stage that the satisfactory solution would require nothing short of a full structure determination of compound B. Therefore, somewhat reluctantly, chemical investigations were concluded by submitting samples of product B for X-ray crystallographic analysis.

A crystalline sample of B was prepared and submitted for X-ray analysis. This compound crystallised from pentane as colourless orthorhombic crystals in the space group  $Pna\ 2_1$ ;  $a = 1813(2)$ ,  $b = 1156(2)$ ,  $c = 945(2)$  pm.;  $U = 1980 \times 10^6$  pm.<sup>3</sup>;  $D_m$  (flotation) =  $1.09$  g.cm.<sup>-3</sup>,  $z = 4$ ,  $D_c = 1.09$  g.cm.<sup>-3</sup>. Data was collected on a Hilger-Watts linear diffractometer. The structure was solved by direct methods and all the non-hydrogen atoms were identified. Refinement by full matrix least squares with anisotropic temperature factors but not hydrogen atoms gave an R factor of 0.089. Thus finally this intractable structure was exposed as 3,3,-dimethyl-5,8-di-t-butyl-9-isopropylidene-5,8-diaza-4,7-dioxa-bicyclo [4,2,1] nonan-2-one. The molecule is shown in fig. 4 and the bond distances and angles agree well with the formulation (85).

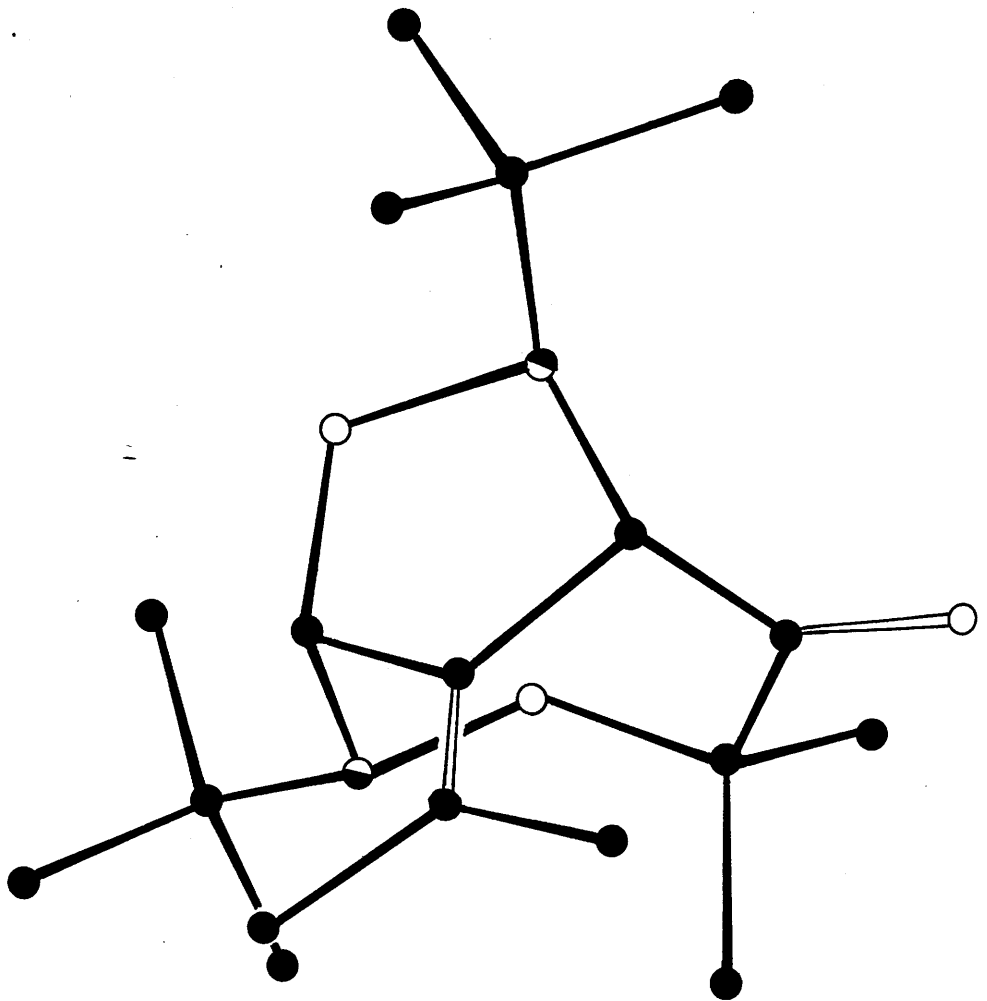

● = C

◐ = N

○ = O

Figure 4

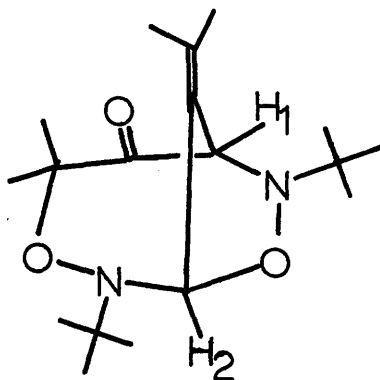

H<sub>1</sub>  $\tau = 5.82$

H<sub>2</sub>  $\tau = 4.31$

**85**

It was rewarding to observe that the proposed partial structure (84) was largely correct, and moreover it was reassuring to find that certain structural features of this molecule rendered its elucidation by spectroscopic and chemical means difficult. Indeed, even if this structure had been deduced by such means, it is doubtful whether we would have believed it!

One of the previously puzzling features of the n.m.r. spectrum was the existence of a high field N-*t*-butyl group ( $\tau = 8.96$ ). However, an examination of molecular models reveals that this group (adjacent to H<sub>2</sub> in 85) is in the shielding zone of the ketone. The unfamiliar chemical shifts of the two protons H<sub>1</sub> and H<sub>2</sub> ( $\tau = 5.82$  and 4.31 respectively) can now be seen to reflect their unusual structural environments. One surprising feature of the n.m.r. spectrum which is not even explained by an examination of molecular models is the homoallylic coupling between the vinylic methyl groups and only H<sub>1</sub> ( $\tau = 5.82$ ,  $J = 0.5\text{Hz.}$ ). While models suggest that both H<sub>1</sub> and H<sub>2</sub> subtend very similar angles in relation to the double bond, no coupling is observed between the vinylic methyls and

$H_2$  ( $\tau = 4.31$ ).

The formulation of the two alcohols produced on lithium aluminium hydride reduction of B is now readily explained. Approach of the hydride reagent from one of two directions will give rise to the epimeric alcohols (86) and (87). Moreover, an examination of molecular

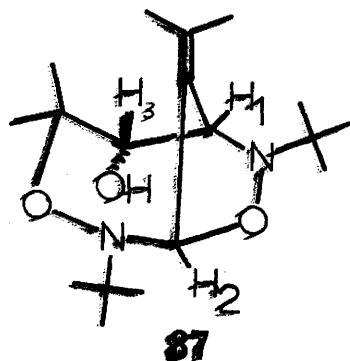
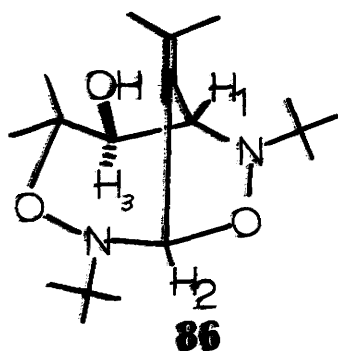

models of these alcohols readily explains the notable differences in their n.m.r. spectra. In what appears to be the most favourable conformation of the seven-membered ring, the alcohol (86) gives rise to a small dihedral angle (ca.  $20^\circ$ ) between the proton  $H_1$  and the newly-introduced methine proton  $H_3$  and hence a small coupling constant between them ( $J$  ca. 1Hz.). In the case of the epimer (87) on the other hand, the dihedral angle between these protons is much larger (ca.  $80^\circ$ ) and therefore the coupling constant is increased ( $J = 7\text{Hz.}$ ). The differences in chemical shift of  $H_1$  and  $H_3$  between the alcohols (86) and (87) probably reflects the complex shielding effects in these systems. However, these conclusions must be considered as tentative in view of the conformational mobility of the seven-membered ring; adoption of a different favoured conformation could easily reverse the above assignments.



Having explained the chemistry and spectroscopy of this bizarre product, we then faced the not inconsiderable task of providing some rationale for its formation from the acetylenic nitroxide (79). As stated previously the unprecedented nature of this decomposition product does not permit much mechanistic speculation however, the existing chemical evidence suggests that the reaction involves dissociation of the nitroxide (79) into 2-nitroso-2-methylpropane and a dimethylpropargyl radical. Chemical studies on acetylenic/allenic radicals to date

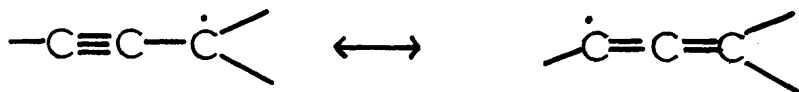

have been confined to reactions aimed at determining the structure of these radicals i.e. the relative contributions from the acetylenic and allenic forms<sup>45,46</sup>. While these studies have led to divergent conclusions regarding the structure of the  $\text{C}_3\text{H}_3$  radical, e.p.r. data for the radicals derived from a number of acetylenes and allenes<sup>47</sup> corresponds to a greater contribution from the acetylenic form.

From an examination of the gross structure of (85) it is possible to gain some insight into its mode of formation. While there are a number of conceivable ways of dissecting the structure (85) into smaller units,

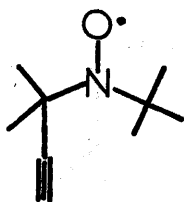

79

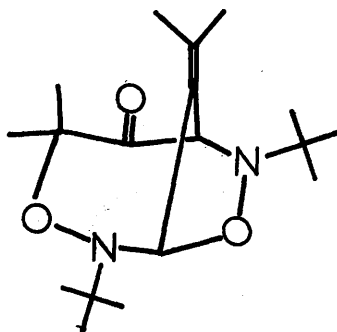

85

one unaltered fact is that the structure is based on smaller units in which the dimethylpropargyl group in (79) is inverted on nitrogen i.e. in the product (85) there are no gem-dimethyl groups adjacent to nitrogen. This implies that the initial step in the formation of (85) might involve isomerization of the nitroxide (79) into the allenic nitroxide (87) via the radical/nitroso intermediate (86). Although the subsequent fate of this

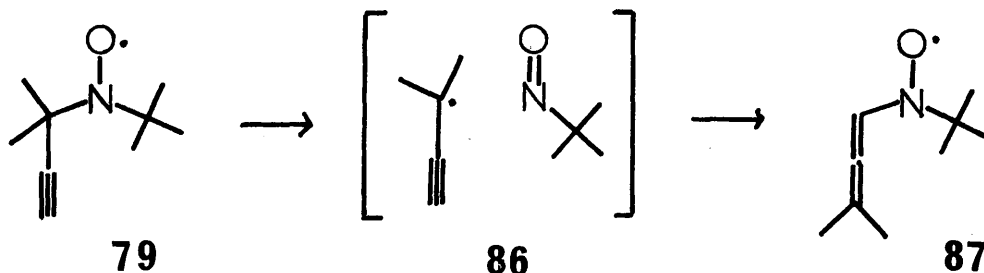

79

86

87

allenic nitroxide (87) under the conditions of decomposition is speculative, one possible mechanism based on this intermediate will be presented briefly as follows. The allenic nitroxide (87) will give rise to considerable spin density at the central carbon atom of the allenic moiety formally via the vinylic radical nitrene (88).

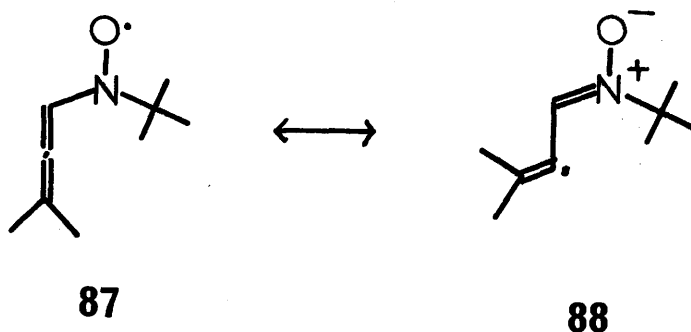

Although the orientation of free radical addition to allenes has been the subject of considerable research<sup>48</sup>, the results are not directly relevant here. Free radical addition of a nitroxide (79 or 87) to the central carbon atom of the allenic group in (87) could yield the nitronium (89) which, as a 1,3-dipolar species,

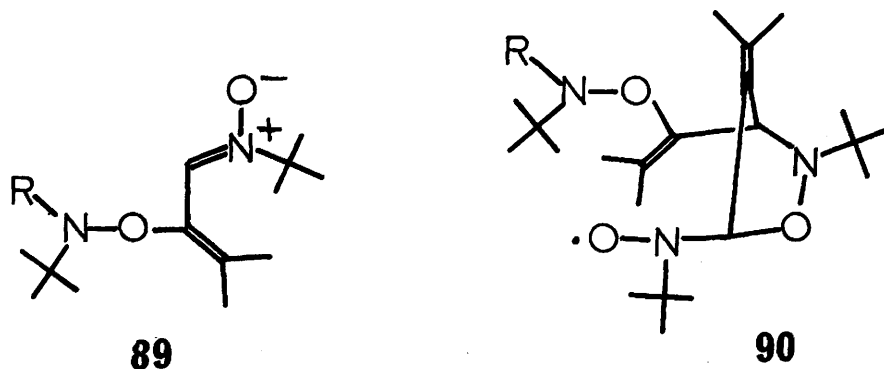

could undergo cycloaddition with another allenic nitroxide (87) to yield the radical (90). Allenes are known to be reactive dipolarophiles<sup>48</sup> although no cycloadditions to nitrones have been reported. Subsequent cyclisation, concerted or stepwise, of (90) would yield the product (85) in addition to some form of amino fragment. However, this proposed mechanism is only tentative and clearly more experimentation is required to unravel the various steps of this complex rearrangement. For example, it may be

possible to trap the proposed nitrene (89) by the addition of a reactive dipolarophile or to trap the allenic nitroxide (87) by suitable diene or 1,3-dipolar species.

In a study of the kinetics of decomposition of the nitroxide (79), no firm quantitative conclusions could be drawn as a result of the complexity of the reaction. Monitoring spectrophotometrically ( $\lambda = 460\text{nm.}$ ) a solution of the nitroxide (79) in benzene at  $55^\circ\text{C}$  resulted in a plot of absorbance against time which indicated that decomposition was not simply first order with respect to the nitroxide (79). This slightly S-shaped curve, (see Fig. 5) which was not attributable to temperature

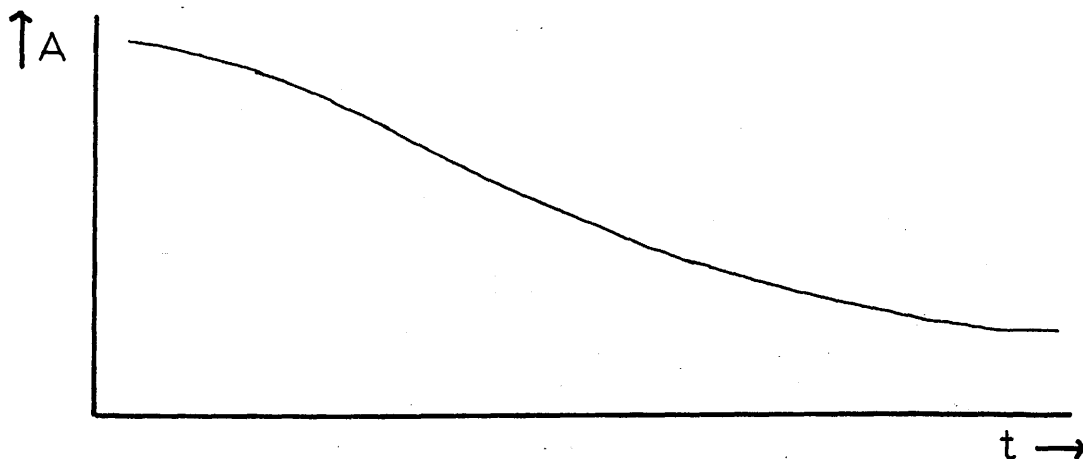
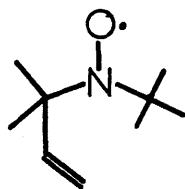
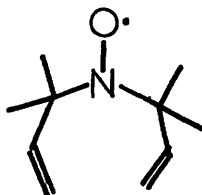
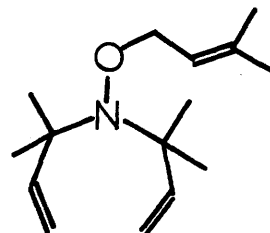

Figure 5

equilibration effects, could be consistent with a mechanism involving initial isomerization of the nitroxide (79) followed by decay of the allenic nitroxide (87). While it was not possible to obtain an accurate value for the half-life of the decay of the nitroxide (79), qualitatively, it was somewhat more stable than the

allylic nitroxide (3) under similar conditions. This would suggest, to a first approximation, that the dimethylallyl radical is slightly more stable than the dimethylpropargyl radical in agreement with the results of Martin and Sanders<sup>42</sup>. However, more work is required to establish first the exact mode of decomposition of the nitroxide (79) and secondly, an accurate value for the rate of its decomposition before this conclusion can be vindicated.

In an extension of these studies on the stability of alkyl-t-butyl nitroxides, the bis-allylic nitroxide (91) was prepared by oxidation of the corresponding amine.<sup>25</sup> As expected by analogy with the closely

**3****91****92**

related nitroxide (3), the bis-allylic nitroxide was unstable and decomposition yielded the hydroxylamine (92) as the major non-volatile product. Further to these studies, the allylic-acetylenic nitroxide (93) was prepared by oxidation of the corresponding amine<sup>25</sup>. It was considered that this nitroxide (93) might provide

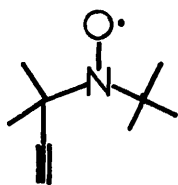
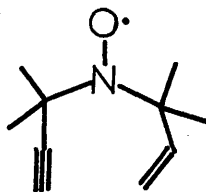
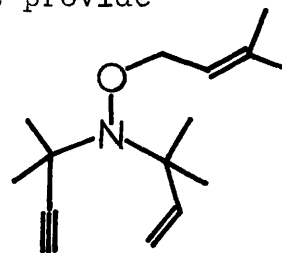
**79****93****94**

qualitative evidence as to the relative stabilities of

the dimethylallyl and dimethylpropargyl radicals and that this could be measured by the yield of the hydroxylamine (94) relative to the initial quantity of the nitroxide (93). In fact decomposition of the nitroxide (93) gave rise to a complex mixture of products (as evidenced by t.l.c.) as was the case for decomposition of the nitroxide (79). Although the hydroxylamine (94) was isolated from this mixture (ca. 25% yield), the complexity of products arising via dimethylpropargyl radicals made it impossible to assess the extent to which the nitroxide (93) decomposed via cleavage into dimethylallyl versus dimethylpropargyl radicals. Therefore no assessment of the relative stabilities of dimethylallyl and dimethylpropargyl radicals was possible by this approach.

The hydroxylamines (92) and (94) exhibited temperature-dependent n.m.r. spectra as a result of slow nitrogen inversion which is characteristic of trialkylhydroxylamines.

In a further extension of this work and in view of the dubiety with respect to the results of Michon and Rassat<sup>13</sup> on the subject, it was decided to investigate the thermal properties of the t-amyl-t-butyl nitroxide radical (95). By analogy with the previously studied nitroxides, it was considered probable that decomposition

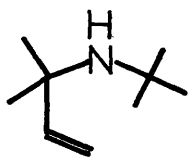

4

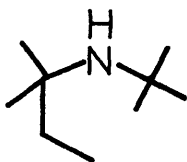

96

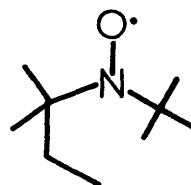

95

might generate initially the t-butyl radical and/or the t-amyl radical. In comparison with the allyl and propargyl radicals however, these saturated alkyl radicals would be expected to be much less stable and in this respect it would be interesting to establish their subsequent course of reaction.

Hydrogenation of the olefinic amine (4) yielded the amine (96) which was readily oxidised to the nitroxide (95). This nitroxide, isolated as a deep red oil, proved to be quite stable in air at room temperature. Thermolysis of this nitroxide as a neat liquid under nitrogen in sealed tubes followed a now familiar pattern. Thus heating the tubes at 140-160°C brought about a spectacular colour change whereby, after about 2 minutes, the red colour rapidly gave way to a green and subsequently to the blue colour characteristic of nitroso monomers. On further heating (up to ca. 5 minutes total), this blue colour gradually faded to green/blue. After cooling, the tubes were further cooled in liquid nitrogen before being opened. The crude product was found to consist primarily of extremely volatile olefins and relatively minor amounts of less volatile hydroxylamines. Analysis of the volatile products by g.l.c., with co-injection of authentic samples, established that they were isobutylene (97), 2-methylbut-1-ene (98) and a relatively minor amount of 2-methylbut-2-ene (99) (in ca. 4: 5: 1 ratio



97



98



99

respectively). The less volatile products moved as one spot on t.l.c. and preparative t.l.c. afforded a colourless oil which by g.l.c. consisted of two principal products (ca. 1 : 2 ratio). The n.m.r. spectrum of this substance was consistent with a mixture of two compounds namely, the hydroxylamines (100) and (101). Although less volatile than the olefins, these

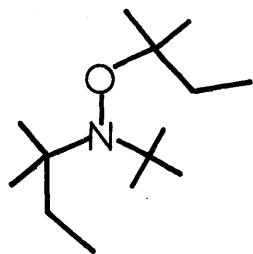

100

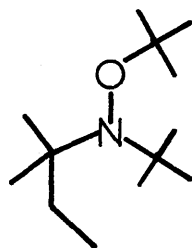

101

hydroxylamines proved to be difficult to handle as a result of their volatility. Moreover, it was found not possible to separate these hydroxylamines by t.l.c. with a variety of solvent systems.

Mechanistically, these results can be accommodated by a process which involves initial cleavage of one of the C-N bonds of the nitroxide to generate either a t-butyl radical or a t-amyl radical and the corresponding nitroso compound. These reactive alkyl radicals once

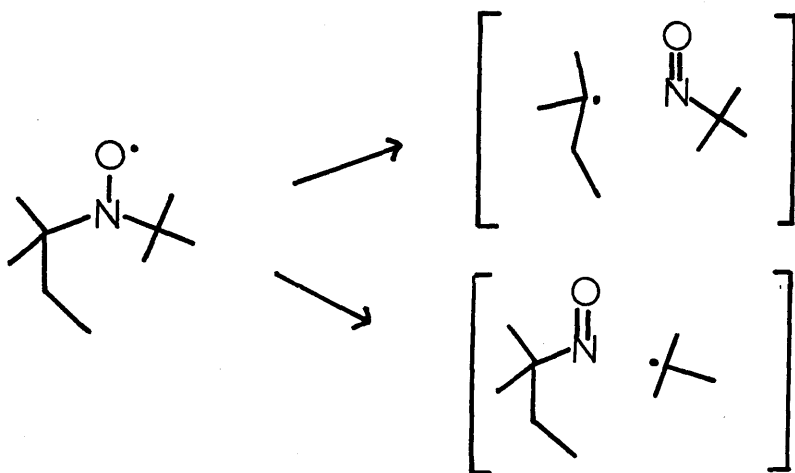



formed are either trapped by another nitroxide radical to form the hydroxylamines (100) and (101) or undergo elimination of H<sup>•</sup> to form the olefins (97), (98) and (99). Recombination of the alkyl radicals with nitroso fragments apparently does not take place since no tri-*t*-butylhydroxylamine (102) was detected by g.l.c. of the crude thermolysis product. It is interesting to note

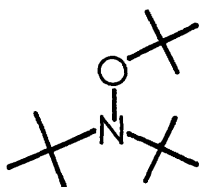

102

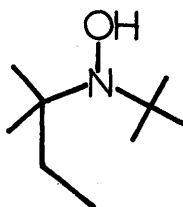

103

that, of the two olefins formed from the *t*-amyl radical, 2-methylbut-1-ene (98) is the predominant one; yet another example of the minor role played by product stability in free radical reactions. The subsequent fate of the hydrogen radicals is unclear. It might have been expected that they would be abstracted by nitroxide radicals forming the hydroxylamine (103) however none of this product was detected in the crude thermolysis mixture (negative test with alkaline 2,3,5-triphenyltetrazolium chloride solution).

While characterisation of the products of thermolysis of the nitroxide (95) has established the basic processes involved, more work is required to determine the relative yields of these products and to determine rate data for its decomposition. Moreover, there may be interesting variations in the relative yields of hydroxylamines and

olefins with the decomposition temperature.

In concluding this discussion of the stabilities of the nitroxide radicals (3), (79) and (95) and some related species, while more experimental data is yet

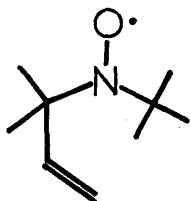

3

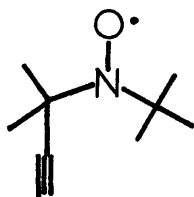

79

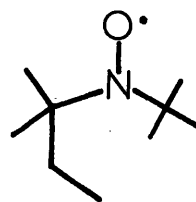

95

required, certain interesting comparisons can be drawn. All three nitroxides are thermally labile and decompose via initial homolysis to alkyl radical and nitroso fragments. This initial C-N bond cleavage is apparently promoted by the steric crowding around nitrogen and is clearly facilitated by resonance stabilization in the alkyl radical fragment. One interesting comparative feature is that, while this similarity exists, the subsequent mode of reaction of the alkyl radical is vastly different in each case. It is in this respect that considerations of the relationship between structure and reactivity become relevant. The saturated alkyl radicals formed by thermolysis of the nitroxide (95), by comparison with the unsaturated allylic and acetylenic/allenic radicals, are much less stable. This instability is reflected in their reactivity in that their predominant course of reaction is not trapping by another nitroxide or nitroso moiety but elimination. A comparison of the decomposition of the olefinic and acetylenic nitroxides

(3) and (79) reveals an interesting case of the formation of unsaturated alkyl radicals of roughly comparable stabilities but with apparently vastly different reactivities. Indeed this comparison provides an example of the sometimes unsatisfactory usage of structure-reactivity relationships. However, the acetylenic nitroxide (79) is a special case in that decomposition is complicated by a complex series of reactions further to the initial reaction of the acetylenic/allenic radical.

EXPERIMENTAL.N-t-butyl-N-1,1-dimethylpropargylamine (5).

The method of choice for the preparation of this compound was found to be that according to Hennion et. al.<sup>25</sup> for the preparation of N-3-t-amyl-N-1,1-dimethylpropargylamine (3-t-amylamino-3-methyl-1-butyne).

Thus, to a mixture of t-butylamine (162g.) and copper bronze powder (0.4g.) was added, with cooling, 3-chloro-3-methyl-1-butyne (30.8g.) and aqueous potassium hydroxide solution (40% by weight, 50 ml.). The reaction was allowed to reach room temperature and, after a period of approximately 4 hours, another portion of aqueous potassium hydroxide solution (40%, 50 ml.) and of 3-chloro-3-methyl-1-butyne (30.8 g.) was added. Eight additional portions of aqueous potassium hydroxide solution ( a total of 664g.) and of 3-chloro-3-methyl-1-butyne (a total of 308g.) were added, as far as possible, at approximately 4 hour intervals over a period of 2 days. Twenty four hours after the final addition, the mixture was steam distilled. The layers of the distillate were separated and the aqueous layer was saturated with sodium chloride and extracted with ether (3 x 250ml.). The ethereal extracts were combined with the organic layer and dried over anhydrous potassium carbonate. Careful removal of solvent under reduced pressure yielded the crude amine which was distilled at atmospheric pressure to yield a slightly yellow coloured liquid (204.lg., b.p. 130-138°C) lit.<sup>7</sup> b.p. 135-136°C.

N-t-butyl-N-1,1-dimethylallylamine (4).

This was prepared by Birch reduction of N-t-butyl-N-1,1-dimethylpropargylamine (5) as opposed to catalytic hydrogenation as used by Hennion et. al.<sup>7</sup> so as to avoid the complication of removing saturated amine impurities in the product.

N-t-butyl-N-1,1-dimethylpropargylamine (5) (204g.) and ammonium sulphate (216g.) were added to liquid ammonia (3l.) in a round bottomed flask fitted with a mechanical stirrer and a 'dry ice'/acetone condenser. The mixture was stirred rigourously and sodium (75g.) was added in small pieces. This was not sufficient to produce the permanent blue colour of excess sodium so ammonium sulphate (26.3g.) was added followed by sodium (9.1g.) in small pieces. This procedure of adding ammonium sulphate and sodium alternately was repeated a further 4 times after which time a further portion of sodium (ca. 5g.) was added. This was sufficient to give rise to the blue colour of excess sodium which gradually faded as the ammonium sulphate slowly dissolved providing reducible protons. In this manner a total of 374g. of ammonium sulphate and 148g. of sodium was added. The mixture was left standing overnight to allow the ammonia to evaporate. Water (2.3l.) was then added and the layers separated. The aqueous layer was saturated with sodium chloride and extracted with ether (3 x 500 ml.). The ether extracts were combined with the organic layer and dried over anhydrous potassium carbonate. Ether was removed under reduced pressure and the resulting liquid was distilled at atmospheric pressure. A fraction (104.4g.)

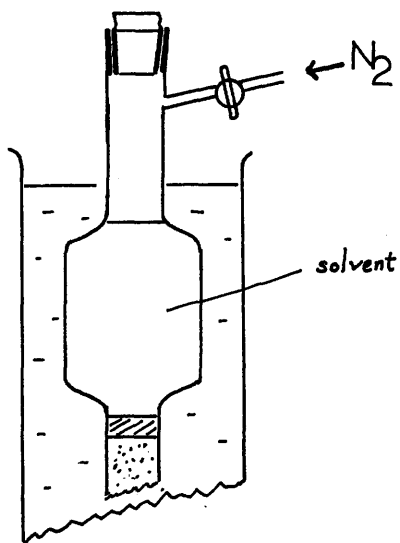
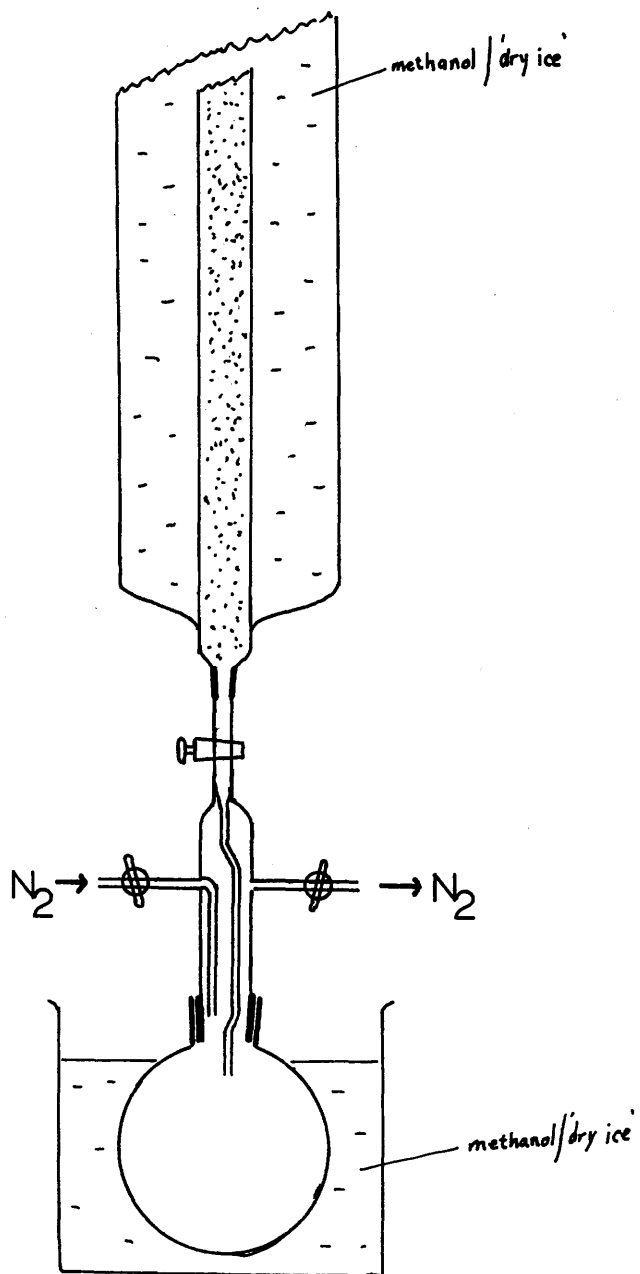

Figure 1



with a b.p. range of 135-142°C was collected, lit.<sup>7</sup>  
b.p. 140°C.

N-(1,1-dimethylallyl)-N-t-butylaminoxyl (3).

This nitroxide, in common with the majority of those prepared during the course of this work, could be oxidised from the corresponding amine either by m-chloroperbenzoic acid or hydrogen peroxide/sodium tungstate.

To a solution of N-t-butyl-N-1,1-dimethylallylamine (4) (37.5g.) in methanol (560ml.) was added, with stirring, sodium tungstate dihydrate (1.13g.), the disodium salt of ethylenediamine tetraacetic acid (1.65g.) and hydrogen peroxide (30%, 375ml.). After stirring at room temperature for 48 hours, the now red solution was transferred to a separating funnel and ether (750ml.) and dilute aqueous sodium hydroxide solution (1M, 375ml.) were added. After separation from the organic extract, the aqueous phase was saturated with sodium chloride and extracted with ether (2 x 250ml.). The ether extracts were combined and dried over anhydrous potassium carbonate. Once this stage was attained and the nitroxide was free of the oxidising medium, decomposition was rapid and the colour of the solution became gradually darker. Careful removal of solvent under reduced pressure yielded the crude nitroxide (3) (25.3g.) which was purified by low temperature column chromatography (see Fig.1.). Thus, the material was chromatographed on basic alumina (grade II, 1Kg.) eluting initially with petroleum ether (40-60) and subsequently with ether/petroleum ether (30%, 40-60). The column was cooled by an outer jacket containing

methanol/'dry ice' at ca. -70 to -80°C. The temperature of the eluent at the exit of the tap attachment was ca. -30°C and the appropriate fraction was collected as one in a flask cooled to ca. -40°C in a methanol/'dry ice' bath. The entire operation was conducted under an atmosphere of dry nitrogen to avoid condensation of water vapour from the atmosphere. The pure nitroxide was collected in one fraction in a large round-bottomed flask from which solvent was removed by 'freeze-drying' on a rotary evaporator, i.e. with the rotating flask temperature at ca. -30°C, the receiver flask was maintained at ca. -60°C again using methanol/'dry ice' baths. This yielded the nitroxide (3) as a dark red oil with a strong camphoraceous odour (12.5g.). This material was stored at all times in a deep freeze to minimise decomposition.

The instability of this compound prevented its complete characterisation

$\tau$ (CDCl<sub>3</sub> plus hydrazobenzene) = 8.83 (9H, singlet), (CH<sub>3</sub>)<sub>3</sub>-C-N, 8.72 (6H, singlet), (CH<sub>3</sub>)<sub>2</sub>-C-N, 4.85-5.25 (2H, multiplet), CH<sub>2</sub>=CH-, 3.46-3.97 (1H, multiplet), CH<sub>2</sub>=CH-

$a_N$  (CCl<sub>4</sub>) = 15.4 Oe.  $g = 2.0070$

$\lambda_{max}$  (CCl<sub>4</sub>) = 462 n.m. ( $\epsilon$  ca. 7.5)

### Studies on the decomposition of N-(1,1-dimethylallyl)-N-t-butylaminoxyl (3)

#### 1. Decomposition at room temperature.

If a sample of the pure nitroxide (3), either neat or in solution, was allowed to stand at room temperature in an open vessel, the colour gradually changed from deep



red through brown to light green over a period of a few hours. If the vessel was sealed then the colour changed to a turquoise blue over the same period of time.

Irrespective of whether the vessel was sealed or not, substantial decomposition occurred by standing overnight at room temperature and t.l.c. (5% ether/60-80 petroleum ether) indicated the formation of two major products less polar than the starting nitroxide. These products were isolated by preparative t.l.c. (10% ether/60-80 petroleum ether) of a sample of the crude decomposition product (300mg.). The major component was obtained as a colourless oil (90.3mg.) identified as N-(1,1-dimethylallyl)-O-(3,3-dimethylallyl)-N-t-butylhydroxylamine (6).

$\nu_{\text{max.}}$  ( $\text{CCl}_4$ ) = 3080, 1670, 1635, 1450, 1360, 1205, 1170, 1010 and  $910\text{cm.}^{-1}$ .

$\tau(\text{CCl}_4)$  = 8.86 (9H, singlet),  $(\text{CH}_3)_3\text{-C-N}$ , 8.70 (6H, broadened singlet)  $(\text{CH}_3)_2\text{-C-N}$ , 8.36 and 8.27 (both 3H, broadened singlets),  $\text{CH}_3\text{-C=C}$ , cis and trans, 5.78 (2H, broad doublet,  $J = 7\text{Hz.}$ ),  $\text{-O-CH}_2\text{-CH=C}$ , 4.96-5.27 (2H, multiplet),  $\text{CH}_2=\text{CH-}$ , 4.70 (1H, broad triplet;  $J = 7\text{Hz.}$ ),  $\text{-O-CH}_2\text{-CH=C}$ , 3.52-4.01 (1H, multiplet),  $\text{CH}_2=\text{CH-}$ .

$M^+$  not observable, strong  $M^+ - 68$  owing to loss of isoprene.

Analysis; Found : C, 74.52; H, 12.12; N, 6.09%.

$\text{C}_{14}\text{H}_{27}\text{NO}$ ; Requires : C, 74.61; H, 12.08; N, 6.21%.

The minor, relatively more polar, component was obtained as a colourless oil (65.1mg.) identified as N-(1,1-dimethylallyl)-O-(2,3-epoxy-3-methylbutyl)-N-t-butylhydroxylamine (7).

$\nu_{\text{Max.}}$  ( $\text{CCl}_4$ ) = 3080, 1615, 1435, 1360, 1340, 1140, 1015 and  $890\text{cm.}^{-1}$ .

$\tau(\text{CDCl}_3) = 8.85$  (9H, singlet),  $(\text{CH}_3)_3\text{-C-N}$ , 8.76 and 8.71 (6H, slightly broadened singlets, splitting due to slow nitrogen inversion),  $(\text{CH}_3)_2\text{-C-N}$ , 7.11 (1H, triplet,  $J=5.5\text{Hz.}$ ),  $-\text{CH}_2\text{-CH}_2\text{-O}$ , 5.98-6.29 (2H, multiplet)  $-\text{O-CH}_2\text{-CH}$ , 5.00-5.28 (2H, multiplet),  $\text{CH}_2=\text{CH-}$ , 3.68-3.98 (1H, multiplet),  $\text{CH}_2=\text{CH-}$ .

$M^+ = 241$ ,  $M^+-15 = 226$

High resolution mass measurement = 241.2041

$\text{C}_{14}\text{H}_{27}\text{NO}_2$  Requires 241.2042

## 2. Decomposition at elevated temperatures.

During the initial course of this work purification of the nitroxide (3) was attempted by distillation but this resulted in rapid decomposition. Thus on heating in an oil bath to ca.  $100^\circ\text{C}$ , rapid decomposition ensued and a volatile blue compound distilled across. This blue distillate subsequently crystallised to a colourless solid. T.l.c. examination (5% ether/60-80 petroleum ether) of the residue indicated the presence of two major products. The minor of these was identified by t.l.c. comparison with an authentic sample as N-(1,1-dimethylallyl)-O-(3,3-dimethylallyl)-N-*t*-butylhydroxylamine (6) as formed by decomposition of the nitroxide at room temperature. The other, major, component was isolated by preparative t.l.c. (5% ether/60-80 petroleum ether) as a colourless oil. This component was identified as N,O-di-(3,3-dimethylallyl)-N-*t*-butylhydroxylamine (18).

$\nu_{\text{max.}}$  (liquid film) = 1680, 1460, 1380, 1360, 1220, 1020 and  $870\text{cm.}^{-1}$ .

$\tau(\text{CDCl}_3) = 8.85$  (9H, singlet),  $(\text{CH}_3)_3\text{-C-N}$ , 8.31 and 8.25 (both 3H, broadened singlets),  $\text{CH}_3\text{-C=C}$ , cis and trans, 6.66

(2H, broad doublet,  $J=7\text{Hz.}$ ),  $-\text{N}-\underline{\text{CH}_2}-\text{CH}=\text{C}$ , 5.75 (2H, broad doublet,  $J=7\text{Hz.}$ ),  $-\text{O}-\underline{\text{CH}_2}-\text{CH}=\text{C}$ , 4.59 (2H, broad quartet, shown by spin-decoupling to be a superimposition of two triplets at 4.51,  $J=7\text{Hz}$  and 4.63,  $J=7\text{Hz.}$ ),  $-\text{O}-\text{CH}_2-\underline{\text{CH}}=\text{C}$ ,  $-\text{N}-\text{CH}_2-\underline{\text{CH}}=\text{C}$ .

$\text{M}^+$  not observable, strong  $\text{M}^+-68$  owing to loss of isoprene.

Analysis ; Found : C, 74.87; H, 12.24; N, 6.46%.

$\text{C}_{14}\text{H}_{27}\text{NO}$  Requires : C, 74.61; H, 12.08; N, 6.21 %.

### 3. Effect of oxygen on decomposition.

A solution of pure nitroxide (3) (269mg.) in carbon tetrachloride (4ml.) was divided into two 2ml. portions. One portion was allowed to decompose at room temperature in the presence of atmospheric oxygen in a lightly stoppered flask. The other portion was thoroughly degassed with a stream of oxygen-free nitrogen and allowed to decompose in an inert atmosphere provided by a constant positive pressure of oxygen-free nitrogen, again at room temperature. After a period of 2.5 days, in each case, the solvent was carefully removed under reduced pressure and the major products isolated by preparative t.l.c. (30% ether/60-80 petroleum ether). In particular the relative quantities of the hydroxylamine (6) and the epoxide (7) formed in each case were noted.

#### a). Aerobic decomposition

Yield of hydroxylamine (6) = 27.8 mg.

Yield of epoxide (7) = 42.1 mg.

#### b). Anaerobic decomposition

Yield of hydroxylamine (6) = 73.8 mg.

Yield of epoxide (7) = 5.5 mg.

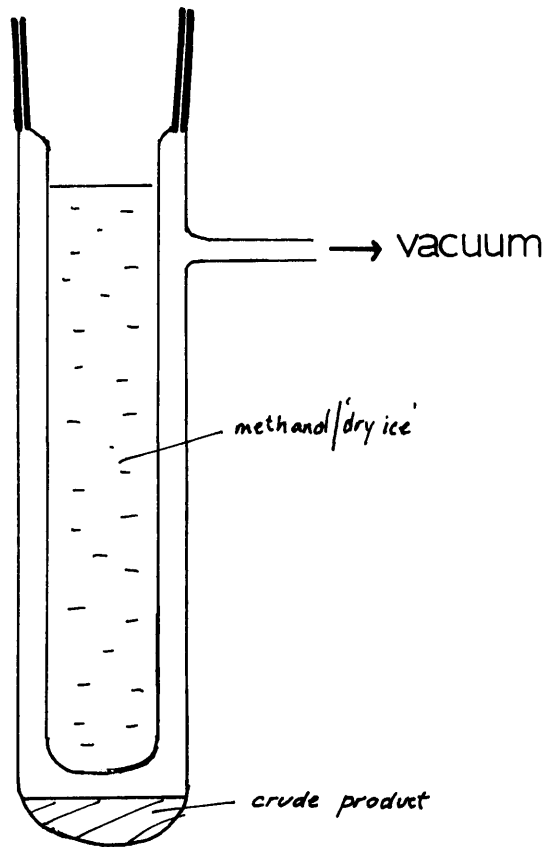

Figure 2

#### 4. Identification of the nitroso compound.

A sample of the pure nitroxide (3) (ca. 100mg.) was allowed to decompose at room temperature in a 'cold-finger' tube temporarily sealed so that any volatile products could not escape (see Fig.2). After approximately 2.5 days, the cold finger was cooled to  $-20^{\circ}\text{C}$  in a methanol/'dry-ice' bath and, under vacuum (ca. 20mm.), the blue nitroso compound readily condensed onto the cold surface. The blue nitroso monomer did not dimerize to the colourless solid on the cold finger. Instead, the blue monomer was transferred to a small vial which was left in the deep freeze. This compound was positively identified as 2-nitroso-2-methylpropane by comparing the melting point of its dimer ( $80-83^{\circ}\text{C}$ ) with that of authentic 2-nitroso-2-methylpropane dimer ( $79-82^{\circ}\text{C}$ ). Melting point of the mixed samples =  $79-82^{\circ}\text{C}$ . The n.m.r. spectrum of the monomer was also consistent with the structure of 2-nitroso-2-methylpropane  $\tau(\text{CDCl}_3) = 8.75$ ,  $(\text{CH}_3)_3\text{-C-N}$ .

#### 5. Solvent effects on the room temperature decomposition.

In three separate experiments a sample of pure nitroxide<sup>†</sup> (3) (350mg.) was allowed to decompose at room temperature as neat liquid and in benzene and isopropanol solutions (3ml. in each case). The progress of each

<sup>†</sup>It was found that, even in the deep freeze, the nitroxide underwent slow decomposition. Relatively pure samples could be obtained, however, by preparative t.l.c. (30% ether/60-80 petroleum ether) providing that the appropriate band was rapidly removed from the plate.

reaction was monitored by analytical t.l.c. (5% ether/60-80 petroleum ether). After about 12 hours significant decomposition had occurred, the major product being the hydroxylamine (6), with the minor product being the epoxide (7) in each case. Following the decomposition in this way over a period of 3 days it was evident that, although all three decompositions yielded the same products, there were some notable differences. First, decomposition in isopropanol was slower than in benzene or than of neat liquid. Secondly, it was clear that the epoxide (7) was a genuine decomposition product and was not formed during oxidation of the amine to the nitroxide. Thirdly, the ratio of the epoxide (7) to the hydroxylamine (6) formed is greater when the nitroxide is allowed to decompose in solution ( e.g. benzene) than when it is allowed to decompose as neat liquid.

#### 6. Decomposition at high dilution.

A dilute solution of the pure nitroxide (3) (100mg.) in n-pentane (200ml.) was allowed to decompose at room temperature in a lightly stoppered flask. After a period of 3 days the pentane was carefully removed under reduced pressure and examination of the residue by analytical t.l.c. (5% ether/60-80 petroleum ether) revealed the same decomposition products as were formed either from neat liquid or more concentrated solutions.

Attempted conversion of  $\underline{N}$ -(1,1-dimethylallyl)- $\underline{O}$ -(3,3-dimethylallyl)- $\underline{N}$ -t-butylhydroxylamine (6) to  $\underline{N}$ -(1,1-dimethylallyl)- $\underline{O}$ -(2,3-epoxy-3-methylbutyl)- $\underline{N}$ -t-butylhydroxylamine (7).

To a solution of the hydroxylamine (6) (50mg.) in

dry methylene chloride (2ml.) was added disodium hydrogen phosphate (ca. 10mg.). To this mixture was added, with stirring, a solution of m-chloroperbenzoic acid (45mg.) in dry methylene chloride (3ml.). The reaction was stirred at room temperature and its progress monitored by analytical t.l.c. (5% ether/60-80 petroleum ether), which indicated that reaction was slow and that after 29 hours, there was still starting material present. After stirring at room temperature for 2 days, more methylene chloride (5ml.) was added and the solution washed first with aqueous sodium sulphite solution (10%, 3ml.) then with aqueous sodium bicarbonate solution (5%, 3ml.) and finally with saturated brine solution (3ml.). After drying over anhydrous potassium carbonate, the solvent was carefully removed under reduced pressure to yield a reddish coloured oil (32mg.) with a camphoraceous odour. T.l.c. analysis (5% ether/60-80 petroleum ether) indicated that none of the desired epoxide (7) had formed and that significant amounts of the starting hydroxylamine remained in addition to two other spots. The least polar of these two spots chromatographed as a red compound and had identical t.l.c. characteristics to N-(1,1-dimethylallyl)-N-t-butylaminoxyl (3) by comparison with an authentic sample. The more polar spot was not identified. This experiment was repeated as described but in one case some glacial acetic acid (6 drops) was added and in another some perchloric acid ('Analar', 6 drops) was added prior to addition of the m-chloroperbenzoic acid solution. However, both experiments indicated that the presence of the acids had no detectable affect upon the course or the

rate of the reaction.

3-Methylene-2,2,4,5,5-pentamethylpyrrolidine (52)

Reduction of N-(1,1-dimethylallyl)-N-1,1-dimethylpropargylamine (51) with sodium in liquid ammonia according to Hennion et. al.<sup>25</sup> yielded the required cyclic amine as a colourless liquid, b.p. 60-68°C (20mm.), lit.<sup>25</sup> 62-68°C (20mm.).

$\tau(\text{CDCl}_3) = 9.13$  (3H, singlet),  $\text{CH}_3\text{-C-N}$ , 9.02 (3H, doublet,  $J=7\text{Hz.}$ ),  $\text{CH}_3\text{-CH-}$ , 8.80, 8.75, 8.70 (all 3H, singlets),  $\text{CH}_3\text{-C-N}$ , 8.40 (1H, broad, exchangeable with  $\text{D}_2\text{O}$ ), N-H, 7.65 (1H, multiplet),  $\text{C=C-CH-CH}_3$ , 5.14 (2H, multiplet),  $\text{CH}_2\text{=C-}$ .

2,2,3,5,5-Pentamethyl-4-methylenepyrrolidine-1-oxyl (46)

To a solution of 2,2,3,5,5-pentamethyl-4-methylenepyrrolidine<sup>25</sup> (52) (0.85g.) in dry methylene chloride (34ml.) was added disodium hydrogen phosphate (1.3g.). The solution was cooled to 0°C in an ice bath and, with stirring, a solution of m-chloroperbenzoic acid (1.04g.) in dry methylene chloride (50ml.) was added dropwise over a period of 30 minutes. Careful removal of the solvent under reduced pressure using a Vigreux column yielded a red/orange partially crystalline material (46) (0.812g.).

Purification was effected by preparative t.l.c. (30% ether/60-80 petroleum ether), m.p. 24-26°C

$\nu_{\text{max}}$  (liquid film) = 3100, 1670, 1460, 1380, 1260, 1210, 1180 and 900  $\text{cm.}^{-1}$ .

$M^+$  = 168 also significant ions at  $m/e = 153, 138, 123$

$a_N(\text{CCl}_4) = 14.0$  oersteds,  $g = 2.005$

$\lambda_{\text{max}} = 436\text{nm}$  ( $\epsilon = 7.2$ )



High resolution mass measurement = 168.1390

$C_{10}H_{18}NO$  requires 168.1388

Thermolysis of 2,2,3,5,5-pentamethyl-4-methylene-pyrrolidine-1-oxyl (46)

A solution of the nitroxide (46) (50mg.) in benzene (2ml.) was refluxed for a period of 19 hours. T.l.c. examination (30% ether/60-80 petroleum ether) of the cooled solution revealed that no detectable reaction had occurred. The same finding resulted after refluxing a solution of the nitroxide (50mg.) in toluene (2ml.) for a period of 17 hours. Similarly, a solution ( $0.887 \times 10^{-1}$  M) of the nitroxide (46) (148.8mg.) in methylcyclohexane (10ml.) was divided between 6 ampoules which were sealed and placed in a thermostatically controlled water bath at 90°C. Ampoules were removed after various periods of time and the solutions analysed on a Gilford 2400-S spectrophotometer measuring absorbance at 450nm. However, it was found that even after 426 hours at 90°C, there was no significant change in the optical density measured at 450nm. and hence no significant decomposition had occurred.

2,2,3,4,5,5-Hexamethylpyrroline-1-oxyl (47)

To a solution of 2,2,3,4,5,5-hexamethylpyrroline<sup>25</sup> (1.0g.) in methanol (15ml.) was added, with stirring, sodium tungstate dihydrate (30mg.), the disodium salt of ethylenediamine tetraacetic acid (45mg.) and hydrogen peroxide (30%, 10ml.). After stirring at room temperature for 48 hours the solution was transferred to a separating funnel and diethyl ether (100ml.) and dilute aqueous sodium

hydroxide solution (1M, 20ml.) were added. After separation from the aqueous phase the organic extract was washed with brine solution (20ml.) and dried over anhydrous potassium carbonate. Careful removal of the solvent under reduced pressure using a Vigreux column yielded the crude red/orange crystalline nitroxide (47) (913mg.).

Purification was attempted by preparative t.l.c. (30% ether/60-80 petroleum ether) however the yellow orange crystals obtained (m.p. 47-49°C) proved to be an inseparable mixture of the title compound (47) and 2,2,3,5,5-pentamethyl-4-methylene-pyrrolidine-1-oxyl (46) (see Section II, Chapter 2). This arises by virtue of the presence of 3-methylene-2,2,4,5,5-pentamethylpyrrolidine (52) as an impurity in 2,2,3,4,5,5-hexamethylpyrrolidine (see Section I).

#### Thermolysis of 2,2,3,4,5,5-hexamethylpyrroline-1-oxyl (47)

A solution of the nitroxide (47) (24mg.) in toluene (1ml.) was refluxed for a period of 16.5 hours. T.l.c. analysis (30% ether/60-80 petroleum ether) of the cooled solution indicated that no significant decomposition had occurred. Similarly, no detectable decomposition resulted from heating a solution of the nitroxide (47) (10mg.) in toluene (1ml.) at 140°C for a period of 20 minutes.

Thermolysis of 3,4-dimethylene-2,2,5,5-tetramethylpyrrolidine-1-oxyl (48)

A solution of the pure nitroxide (48) (50mg.) in benzene (2ml.) was refluxed for a period of 15 hours. T.l.c. analysis (30% ether/60-80 petroleum ether) of the cooled solution revealed that only a minor amount of very polar material had formed. The benzene was carefully removed under reduced pressure and the same sample of nitroxide was refluxed in toluene (2ml.) for a period of 17 hours. T.l.c. examination (30% ether/60-80 petroleum ether) of the cooled solution indicated that the major component was the starting nitroxide (48) and that only a small amount of decomposition had produced some polar material.

The preparation of this nitroxide is described in Section I.

N-t-butyl-N-1,1-dimethylpropargylaminoxyl (79).

Oxidation of N-t-butyl-N-1,1-dimethylpropargylamine<sup>7</sup> (5) (15g.) by the standard method using sodium tungstate/hydrogen peroxide but for a period of 1 week, yielded the crude product as a red semi-crystalline oil (10g.). Partial purification of this material was effected by chromatography on a column of basic alumina (grade II, 300g.) eluting initially with petroleum ether (40-60) and subsequently with ether/petroleum ether (20%, 40-60 grade). This yielded the nitroxide as yellow needles (5.7g.). Partial purification could also be effected by preparative t.l.c. (30% ether/60-80 petroleum ether). As with the

olefinic nitroxide (3), this nitroxide proved to be too unstable to be fully characterised. However, since this compound readily crystallised and decomposition was slower in the solid form, relatively pure samples could be obtained by recrystallisation from ice-cold 60/80 petroleum ether as yellow needles, m.p. 64°C (lit.<sup>4A</sup> m.p. 64°C)

$\tau(\text{CDCl}_3 + \text{hydrazobenzene}) = 8.70$  (9H, singlet),  $(\text{CH}_3)_3\text{-C-N}$ , 8.47 (6H, singlet)  $(\text{CH}_3)_2\text{-C-N}$ , 7.62 (1H, singlet),  $\text{HC}\equiv\text{C-}$ .

$a_{\text{N}} = 15.4$  Oe.,  $g = 2.0065$ . ( $\text{CCl}_4$ ).

Studies on the decomposition of *N*-*t*-butyl-*N*-1,1-dimethylpropargylaminoxyl (79).

In a typical thermolysis, a solution of the nitroxide (79) (193mg.) in benzene (3ml.) was heated in an oil bath at 80°C. After about 4 minutes the colour of the solution rapidly changed from red to emerald green and a volatile blue material (presumably nitroso compound) was seen to be condensing around the base of the condenser. On further heating, the green colour faded slightly and after a total of ca. 8 minutes heating, the then yellow/green solution was allowed to cool. T.l.c. examination (30% ether/60-80 petroleum ether) of the solution revealed the presence of at least six products with total consumption of the starting nitroxide. Preparative t.l.c. (30% ether/60-80 petroleum ether) of the crude product allowed the isolation of two of the components. The first one (product A); a minor non-polar component, was

isolated as a colourless oil (19.4mg.) which appeared to be unstable.

$\nu_{\max.} (\text{CCl}_4) = 3300, 1725, 1665, 1630, 1460, 1380, 1360, 1260 \text{ and } 960 \text{ cm.}^{-1}$ .

$\tau(\text{CDCl}_3) = 5.40$  (1H, singlet),  $6.05$  (1H, broad singlet),  $7.65$  (1H, singlet),  $8.25$  (3H, singlet),  $8.46$  (3H, singlet),  $8.51$  (3H, singlet)  $8.68$  (9H, singlet),  $9.09$  (impurity).

High resolutions mass measurement = 195.1609

$\text{C}_{12}\text{H}_{21}\text{NO}$  requires 195.1623

The second one (product B); the major decomposition product (ca. 40% yield), which had a similar Rf. value to the starting nitroxide (ca. 0.5 in 30% ether/60-80 petroleum ether) was isolated as a slightly coloured oil (53.6mg.). Further purification by preparative t.l.c. (30% ether/60-80 petroleum ether) yielded a colourless oil (47.4 mg.) which crystallised on standing, m.p.  $62^\circ\text{C}$ .

$\tau(\text{CDCl}_3) = 8.96$  (9H, singlet),  $8.80$  (9H, singlet),  $8.66$  (3H, singlet),  $8.62$  (3H, singlet),  $8.31$  and  $8.22$  (both 3H, singlets showing long range coupling ca. 0.5Hz. to the resonance at  $\tau = 5.82$ ),  $5.82$  (1H, broad singlet),  $4.31$  (1H, broadened singlet).

$M^+ = 324$ , significant ions at  $m/e = 238, 237, 181, 167, 109$ .

$\nu_{\max.} (\text{CCl}_4) = 1713, 1360, 1220, 1165, 1120, 1070, 980, 950$  and  $890 \text{ cm.}^{-1}$   
High resolution mass measurement = 324.2405

$\text{C}_{18}\text{H}_{32}\text{N}_2\text{O}_3$  requires 324.2413

In a similar experiment, a solution of the nitroxide (79) (300mg.) in methylcyclohexane (2ml.) was heated rapidly ( $80-90^\circ\text{C}$  for 3.5 minutes) in a micro-distillation unit in an attempt to distil off the volatile blue nitroso compound as it formed during thermolysis. Although

some nitroso compound did distil across, t.l.c. examination (30% ether/60-80 petroleum ether) of the residue revealed the same mixture of products as had been observed previously. Also, isolation of the two components A and B by preparative t.l.c. revealed that they had been formed in similar relative proportions.

Another experiment was conducted in a similar fashion but with the exclusion of oxygen. Thus a solution of the nitroxide (79) in benzene was thoroughly degassed by bubbling oxygen-free nitrogen through the solution and then heated at 80°C for 5 minutes under an atmosphere of nitrogen. However, t.l.c. analysis of the product indicated that the same components were formed in the same relative amounts as had been the case with oxygen present.

Similarly, when a solution of the nitroxide (79) (100mg.) in benzene (1ml.) was allowed to decompose at room temperature, t.l.c. monitoring of the solution showed a steady build up of the same mixture of products as were formed at higher temperatures. In particular, the relative yield of the non-polar product A was similar.

#### Reaction of decomposition product A with 2-nitroso-2-methylpropane.

A solution of the pure non-polar decomposition product A (60mg.) and 2-nitroso-2-methylpropane (120mg. dimer) in benzene (3ml.) was sealed in a glass tube. After heating the tube at 90°C for 6 minutes, the blue colour of the nitroso monomer still persisted and t.l.c. analysis (30% ether/60-80 petroleum ether) of the solution indicated

no detectable formation of product B.

Reduction of the major decomposition product B with lithium aluminium hydride.

A solution of the product B (120mg.) in anhydrous ether (6ml.) was cooled to 0°C in an ice bath. To this solution was added dropwise, with stirring, a solution of lithium aluminium hydride (20mg.) in anhydrous ether (2ml.). After stirring at 0°C for 0.5 hour, aqueous sodium hydroxide solution (2M, 5ml.) and ether (20ml.) were added and the solution transferred to a separating funnel. The ether extracts were separated, washed with saturated brine solution (5ml.), dried over anhydrous potassium carbonate and the ether removed under reduced pressure. This yielded very little material indeed and the aqueous phase was re-extracted with a more polar solvent, namely, chloroform (25ml.). The chloroform extracts were washed with saturated brine solution (5ml.) and dried over anhydrous potassium carbonate. Removal of the chloroform under reduced pressure yielded an oil (124mg.). T.l.c. examination (30% ether/60-80 petroleum ether) of this material indicated complete reduction of the starting material (B) with the formation of two products; one polar, the other relatively non-polar. These products were isolated by preparative t.l.c. (50% ether/60-80 petroleum ether) and the less polar product (product C) was obtained as a colourless crystalline solid (40mg.). m.p. 114-116°C.

$\nu_{\max.}$  (CCl<sub>4</sub>) = 3360 (very broad, concentration independent),

1360, 1215, 1150, 1060, 970 and 890  $\text{cm.}^{-1}$ .

$\tau(\text{CDCl}_3) = 8.93$  (9H, singlet), 8.82 (15H, broad singlet), 8.26 and 8.23 (both 3H, singlets), 6.67 (1H, very broad singlet : changes with  $\text{D}_2\text{O}$  to doublet  $\tau = 6.72$ ,  $J = 7\text{Hz.}$ ), 5.90 (1H, broadened doublet,  $J = 7\text{Hz.}$ ), 4.25 (1H, singlet).  $M^+ = 326$ , significant ions at  $m/e = 311, 268, 254, 239, 198, 183$ .

High resolution mass measurement = 326.2564

$\text{C}_{18}\text{H}_{34}\text{N}_2\text{O}_3$  requires 326.2564

The more polar product (product D) of the reduction was obtained as an oil which subsequently crystallised to a colourless solid (30mg.), m.p. 149-151°C.

$\nu_{\text{max.}}(\text{CCl}_4) = 2810$  (sharp, medium intensity peak), 1460, 1385, 1360, 1215, 1155, 1090 and 890  $\text{cm.}^{-1}$ .

$\tau(\text{CDCl}_3) = 8.96$  (9H, singlet), 8.81 (12H, slightly broadened singlet), 8.60 (3H, broad singlet), 8.23 and 8.14 (both 3H, slightly broadened singlets), 6.28 (1H, very broad singlet; with  $\text{D}_2\text{O}$  becomes sharper singler  $J \approx 1\text{Hz.}$ ), 6.07 (1H, broad singlet,  $J \approx 1\text{Hz.}$ ), 4.31 (1H, broadened singlet).

$M^+ = 326$

High resolution mass measurement = 326.2564

$\text{C}_{18}\text{H}_{34}\text{N}_2\text{O}_3$  requires 326.2569

Attempted catalytic hydrogenation of the major decomposition product B.

A solution of product B (70mg.) in methanol (10ml.) was hydrogenated at atmospheric pressure and at room



temperature over 5% palladium/charcoal (5mg.). After 24 hours, t.l.c. (30% ether/60-80 petroleum ether) indicated that no significant reaction had taken place. This negative result was also obtained when the same solution was hydrogenated under similar conditions with 10% palladium/charcoal for 24 hours. Hydrogenation did proceed, as evidenced by t.l.c., under similar experimental conditions using Rainey nickel as a catalyst. After 4 hours the two major products were isolated by preparative t.l.c. (30% ether/60-80 petroleum ether) but analysis of their n.m.r. spectra showed that they bore no useful structural resemblance to the decomposition product B.

#### Bis-(1,1-dimethylallyl) amine

This was prepared by catalytic hydrogenation of bis-(1,1-dimethylpropargyl) amine on 10% palladium/charcoal by the method of Hennion *et. al.*<sup>25</sup>. Distillation yielded a colourless liquid, b.p. 50-60°C (15mm.), lit.<sup>25</sup> b.p. 65-69°C (20mm.).

#### Bis-(1,1-dimethylallyl) aminoxyl (91)

Oxidation of bis-(1,1-dimethylallyl) amine (500mg.) with sodium tungstate/hydrogen peroxide according to the standard procedure yielded a crude red oil (413mg.). Attempted purification by preparative t.l.c. (30% ether/60-80 petroleum ether) yielded the deep red nitroxide (109.8mg.) however subsequent t.l.c. indicated that decomposition was too rapid to allow isolation of the pure nitroxide (91)  $a_N = 14.7 \text{ Oe}$ ,  $g = 2.006$

The semi-pure nitroxide (91) was dissolved directly in benzene (2ml.), the solution thoroughly degassed with a stream of nitrogen and allowed to stand at room temperature under a positive pressure of nitrogen in a sealed flask. After a period of 4.5 days, the benzene was removed under reduced pressure and by preparative t.l.c. (30% ether/60-80 petroleum ether), the major product of decomposition was isolated as a colourless oil (52.7mg.). On the basis of spectral data, this compound was identified as N-di-(1,1-dimethylallyl)-O-3,3-dimethylallylhydroxylamine (92).

$\nu_{\text{max}}$ . (liquid film) = 3100, 1680, 1640, 1460, 1420, 1380, 1170, 1020 and 910  $\text{cm.}^{-1}$ .

$\tau(\text{CDCl}_3)$  = 8.71 (12H, singlet),  $(\text{CH}_3)_2\text{-C-N}$ , 8.33 and 8.24 (both 3H, broadened singlets),  $\text{CH}_3\text{-C=C}$ , cis and trans, 5.68 (2H, broad doublet,  $J = 7\text{Hz}$ ),  $-\text{O}-\text{CH}_2\text{-CH=C}$ , 4.85-5.25 (4H, multiplet),  $\text{CH}_2=\text{CH-}$ , 4.61 (1H, broad triplet,  $J = 7\text{Hz}$ ),  $-\text{CH}_2\text{-CH=C}$ , 3.38-3.91 (2H, multiplet),  $\text{CH}_2=\text{CH-}$ .

Analysis ; Found : C, 76.15; H, 11.42; N, 5.73%.

$\text{C}_{15}\text{H}_{27}\text{NO}$  Requires : C, 75.90; H, 11.46; N, 5.90%.

#### N-(1,1-dimethylallyl)-N-1,1-dimethylpropargylamine

This was obtained by the alkylation of 3-amino-3-methyl-1-butene with 3-chloro-3-methyl-1-butyne according to Hennion *et. al.*<sup>25</sup>. Distillation yielded a colourless oil, b.p. 62-65°C (20mm.), lit.<sup>25</sup> b.p. 62-68°C (20mm.)

$\tau(\text{CDCl}_3)$  = 8.69 (6H, singlet),  $(\text{CH}_3)_2\text{-C-N}$ , 8.63 (6H, singlet),  $(\text{CH}_3)_2\text{-C-N}$ , 7.74 (1H, singlet),  $\text{HC}\equiv\text{C-}$ , 4.79-5.25 (2H, multiplet),  $\text{CH}_2=\text{CH-}$ , 3.65-4.13 (1H, multiplet),  $\text{CH}_2=\text{CH-}$ .

N-(1,1-dimethylallyl)-N-1,1-dimethylpropargylaminoxyl (93)

Oxidation of N-(1,1-dimethylallyl)-N-1,1-dimethylpropargylamine (300mg.) with m-chloroperbenzoic acid according to the standard procedure yielded a crude red oil (250mg.). As in the case of the other allyl-substituted nitroxide radicals, this compound was found to be too unstable to be characterised fully. However partial purification was effected by preparative t.l.c. (30% ether/60-80 petroleum ether) to yield a deep red oil (150mg.).

$$a_N = 15.20e, \quad g = 2.006$$

This partially pure nitroxide was dissolved directly in benzene (3ml.) and allowed to decompose at room temperature under an atmosphere of nitrogen. After a period of 5 days, t.l.c. (30% ether/60-80 petroleum ether) indicated complete decomposition to a number of products; at least 5 by t.l.c. analysis. Of the major decomposition products, the least polar one was isolated by preparative t.l.c. (30% ether/60-80 petroleum ether) as a colourless oil (32mg.). On the basis of spectral data, this compound was identified as N-(1,1-dimethylallyl)-O-(3,3-dimethylallyl)-N-(1,1-dimethylpropargyl)hydroxylamine (94).

$$\nu_{\max.} = 3300, 3100, 1720, 1670, 1630, 1460, 1380, 1170, 1020 \text{ and } 920 \text{ cm.}^{-1}.$$

$\tau(\text{CDCl}_3) = 8.53$  (6H, singlet broadened by slow nitrogen inversion),  $(\text{CH}_3)_2\text{-C-N}$ , 8.31 and 8.24 (both 3H, singlets slightly broadened by slow nitrogen inversion),  $(\text{CH}_3)_2\text{-C-N}$ , 7.69 (1H, singlet),  $\text{HC}\equiv\text{C-}$ , 5.62 (2H, broad doublet,  $J=7\text{Hz.}$ ),  $-\text{O-CH}_2\text{-CH-}$ , 4.75-5.20 (2H, multiplet),  $\text{H}_2\text{C=CH-}$ ,

4.57 (1H, broad triplet,  $J=7\text{Hz.}$ )  $-O-CH_2-\underline{CH}=C-$ , 3.40-3.93  
 (1H, multiplet),  $CH_2=\underline{CH}-$ .

Analysis ; Found : C, 76.36; H, 10.69; N, 5.77%.

$C_{15}H_{25}NO$  Requires: C, 76.55; H, 10.71; N, 5.95%.

N-t-butyl-N-t-amylamine (96).

This amine was prepared by catalytic reduction of N-1,1-dimethylallyl-N-t-butylamine (4) according to the general method of Hennion et. al.<sup>25</sup> for reduction of these unsaturated blocked amines. Thus, to a solution of N-1,1-dimethylallyl-N-t-butylamine (4) (14.1g.) in ethanol (50ml.) was added Rainey nickel (ca. 2g., wet with ethanol). The solution was hydrogenated at room temperature at 45 p.s.i. for a total of 45 hours. The catalyst was then removed by filtration and the ethanol removed by distillation at atmospheric pressure. The remaining liquid was distilled at atmospheric pressure to yield the title compound (96) as a colourless liquid, b.p.  $140^{\circ}\text{C}$ , lit.<sup>7</sup> b.p.  $144^{\circ}\text{C}$ .

The nm.r. spectrum indicated the total absence of any olefinic starting material

$\tau(\text{CDCl}_3) = 9.11$  (3H, triplet,  $J = 7\text{Hz.}$ ),  $\underline{CH}_3-\underline{CH}_2-$ , 8.86 (6H, singlet),  $(\underline{CH}_3)_2-\text{C}-\text{N}$ , 8.81 (9H, singlet),  $(\underline{CH}_3)_3-\text{C}-\text{N}$ , 8.75 (2H, quartet.  $J = 7\text{Hz.}$ )  $\underline{CH}_3-\underline{CH}_2-\text{C}$ .

N-t-butyl-N-t-amylaminoxyl (95)

Oxidation of N-t-butyl-N-t-amylamine (96) (1g.) with sodium tungstate/hydrogen peroxide according to the standard procedure for a period of 2 days yielded the crude product as a red oil (460mg.). Purification by

preparative t.l.c. (30% ether/60-80 petroleum ether) yielded a volatile red liquid (285mg.) with the strong camphoraceous odour typical of these nitroxides. This nitroxide was apparently stable at ambient temperatures.

$\nu_{\max.}$  (liquid film) = 1470, 1380, 1300, 1200, 1070, 1020 and 800  $\text{cm.}^{-1}$ .

$a_{\text{N}} = 15.20e$   $g = 2.006$

$\lambda_{\max.} = 445\text{nm.}$  ( $\epsilon = 8.2$ )

Analysis: Found : C, 68.54; H, 12.57; N, 8.90%.

$\text{C}_9\text{H}_{20}\text{NO}$  Requires : C, 68.30; H, 12.68; N, 8.85%.

#### Thermolysis of *N*-*t*-butyl-*N*-*t*-amylaminoxyl (95)

A sample of the neat nitroxide (95) (252mg.) was sealed under nitrogen in a tube which was heated in an oil bath at 160°C. After approximately 2 minutes, the liquid changed colour from red through green to the blue colour characteristic of nitroso compounds. On further heating, this blue colour gradually faded to green/blue. After a total time of 5 minutes at 160°C, the tube was allowed to cool. The tube was opened after cooling in liquid nitrogen to avoid loss of any volatile products. This crude thermolysis product gave a negative test with alkaline 2,3,5-triphenyltetrazolium chloride solution (standard test for N-O-H hydroxylamines). The n.m.r. spectrum of this crude product indicated the formation of a number of products some of which were olefinic.

$\tau(\text{CDCl}_3)$  (major peaks only) = 8.69 (singlet), 8.50 (singlet), 8.25 (broadened singlet), 5.27 (broad singlet).

The deuteriochloroform was removed from this solution under reduced pressure using a rotary evaporator to leave

a slightly yellow coloured oil. The n.m.r. spectrum of this material indicated that some components including the olefinic ones were now absent from the mixture. Clearly these components are volatile and were being lost during evaporation under reduced pressure.

$\tau(\text{CDCl}_3)$  (major peaks only) = 8.68 (singlet), 8.49 (singlet).

The major non-volatile product was isolated by preparative t.l.c. (5% ether/60-80 petroleum ether) as a colourless oil (45.4mg.). This product gave one spot (using U.V. light) on analytical t.l.c. However, g.l.c. of a solution of this material in ether on a KOH/Carbowax column at 90°C indicated that it was in fact a mixture of three components (two major) (Retention times at 20lb./in.<sup>2</sup>; 45 secs., 90 secs and 171 secs. The n.m.r. spectrum was consistent with there being two major components.

$\tau(\text{CDCl}_3)$  = 9.16(triplet,  $J=7\text{Hz.}$ ), 8.72 (singlet), 8.70 (singlet), 8.54 (singlet), 8.50 (singlet), 8.12 (quartet,  $J=7\text{Hz.}$ ). (as a mixture, integration is not meaningful).

It subsequently became apparent that even the components of this mixture were volatile since by transferring and removing solvent (e.g. ether) under reduced pressure, its weight was drastically reduced.

In a similar experiment, a sample of the neat nitroxide (95) (225mg.) was heated under nitrogen in a sealed tube at 140°C for 20 minutes. The same sequence of colour changes were observed as had been noted previously.

This time the tube was cooled in liquid nitrogen, opened and ether (ca. 5ml.) added. This cooled solution was analysed directly by g.l.c. on a 15%  $\beta, \beta^1$ -oxydipropionitrile column at 35°C with gas flow rate of 15lb./in.<sup>2</sup>. Under these conditions, three volatile compounds were detected

all with retention times shorter than diethyl ether. By co-injection with authentic samples, these volatile products were identified as isobutylene (Rt=48secs.), 2-methylbut-1-ene (Rt=60secs.) and a minor amount of 2-methylbut-2-ene (Rt.=66secs.). Care was taken to ensure that, at all times, the solution was kept cool (with liquid nitrogen) to avoid loss of volatile components. Preparative t.l.c. (5% ether/60-80 petroleum ether) of the remaining non-volatile material yielded the same colourless oil as previously found (20mg.).

REFERENCES.

1. O.H. Griffith, J.F.W. Keana, S. Rottschaefter and T.A. Warlick, J. Amer. Chem. Soc., 89, 5072, 1967.
2. A.R. Forrester and S.P. Hepburn, J. Chem. Soc. (C), 3822, 1971.
3. For reviews on this subject see:-  
G. Scott, European Polymer Journal, 189, 1969.  
P.I. Levin and V.V. Mikhailov, Russ. Chem. Rev., 39, 799, 1970.
4. For reviews on this subject see:-  
G.P. Rabold, J. Polym. Sci., Part A-1, 7, 1187, 1203, 1969.
5. A.R. Forrester, J.M. Hay and R.H. Thomson, Organic Chemistry of Stable Free Radicals, Chap. 5, Academic Press, 1968. E.G. Rozantsev, Free Nitroxyl Radicals, Plenum Press, 1970.
6. B.H. Hoffmann and T.B. Eames, J. Amer. Chem. Soc., 91, 2169, 5168, 1969.
7. G.F. Hennion and R.S. Hanzel, J. Amer. Chem. Soc., 82, 4908, 1960.
8. D.E. Van Sickle, F.R. Mayo, E.S. Gould and R.M. Arluck, J. Amer. Chem. Soc., 89, 977, 1967 and references cited therein.
9. R.L. Augustine, Oxidation Vol. 1, Chap. 5, Marcel Dekker, 1969.
10. N. LeBel, Trans. N.Y. Acad. Sci., 27, 858, 1965.
11. G. Fodor, Tetrahedron, 1, 86, 1957.
12. O.W. Meander and E.G. Janzen, J. Org. Chem., 34, 4072, 1969.



13. J. Michon and A. Rassat, personal communication.
14. P.S. Engel and P.D. Bartlett, J. Amer. Chem. Soc., 92, 5883, 1970, and references cited therein.
15. P.S. Engel and D.J. Bishop, J. Amer. Chem. Soc., 94, 2148, 1972.
16. G.S. Hammond, J. Amer. Chem. Soc., 77, 334, 1955,
17. J.K. Kochi and P.J. Krusic, J. Amer. Chem. Soc., 90, 7157, 1968.
18. J.K. Kochi and P.J. Krusic, J. Amer. Chem. Soc., 92, 4110, 1970.
19. W.R. Dolbier and C.A. Harmon, J.C.S. Chem. Comm., 150, 1971.
20. M.J. Perkins in Essays on Free Radical Chemistry R.O.C. Norman, Ed., Chem. Soc. Special Publ. No. 24, Chap. 5, 1970.
21. E.G. Janzen, Accounts Chem. Res., 4, 31, 1971.
22. C. Lagercrantz, J. Phys. Chem., 75, 3466, 1971.
23. E.G. Janzen and B.J. Blackburn, J. Amer. Chem. Soc., 91, 4481, 1969.
24. C. Rüchardt, Angew. Chem. Int. Ed. Engl., 9, 830, 1970.
25. G.F. Hennion and C.V. Di Giovanna, J. Org. Chem., 30, 2645, 1965.
26. R.B. Woodward and R. Hoffmann, Angew. Chem. Int. Ed. Engl., 8, 781, 1969.
27. J.E. Baldwin, W.F. Erickson, R.E. Hackler and R.M. Scott, J.C.S. Chem. Comm., 576, 1970.
28. J.E. Baldwin and J.A. Walker, J.C.S. Chem. Comm., 354, 1972.

29. R.B. Woodward and R. Hoffmann, J. Amer. Chem. Soc., 87, 2511, 1965 and references cited therein.
30. J.E. Baldwin, J.E. Brown, G. Hofle, J. Amer. Chem. Soc., 93, 788, 1971.
31. R.W. Jemison, T. Laird and W.D. Ollis, J.C.S. Chem. Comm., 556, 1972.
32. W.C. Danen and C.T. West, J. Amer. Chem. Soc., 93, 5582, 1971.
33. S. Terabe and R. Konaka, J.C.S. Perk. II, 369, 1973, ibid., 2163, 1972.
34. S. Terabe and R. Konaka, J. Amer. Chem. Soc., 93, 4306, 1971.
35. W.C. Danen, personal communication.
36. cf. G. Hofle and J.E. Baldwin, J. Amer. Chem. Soc., 93, 6307, 1971.
37. B. Capon, Quart. Rev., 18, 45, 1964.
38. S.J. Cristol and R.V. Barbour, J. Amer. Chem. Soc., 90, 2832, 1968.
39. A.L.J. Beckwith and G. Philipou, J.C.S. Chem. Comm., 658, 1971.
40. M.I. Page and W.P. Jencks, Proc. Nat. Acad. Sci., U.S.A., 68, 1678, 1971.
41. A.L.J. Beckwith in Free Radical Reactions, W.A. Waters, Ed., M.T.P. International Review of Science, Series 1, Vol. 10, Butterworths.
42. M.M. Martin and E.B. Sanders, J. Amer. Chem. Soc., 89, 3777, 1967.
43. J.C. Martin and J.W. Timberlake, J. Amer. Chem. Soc., 92, 978, 1970.
44. E.G. Rozantsev and R.S. Burmistrova, Dokl. Akad. Nauk SSSR, 166, 129, 1966.

45. M.C. Caserio and R.E. Pratt, Tet. Lett., 91, 1967 and references cited therein.
46. M.L. Poutsma, Tet. Lett., 2925, 1969 and references cited therein.
47. J.K. Kochi and P.J. Krusic, J. Amer. Chem. Soc., 92, 4110, 1970.
48. T.F. Rutledge, Acetylenes and Allenes, Chap.1, Reinhold, 1969.

## CHAPTER 2.

DISCUSSION.

One of the initially confusing aspects of the decomposition of the olefinic nitroxide (1) (as discussed in Chapter 1 of this Section) was the formation of the hydroxylamine (2) at elevated temperatures. Thus when

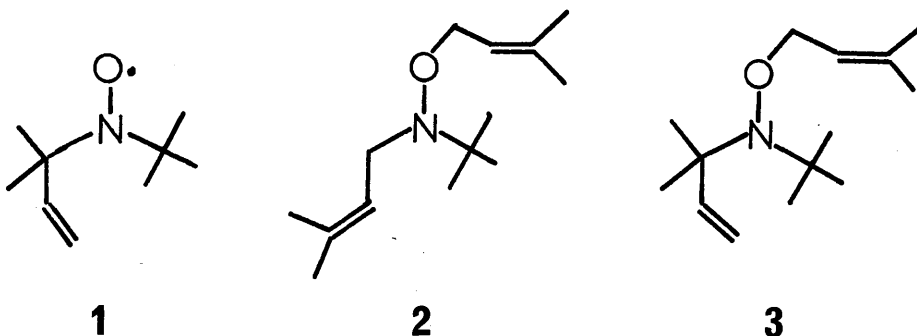

the distillation of the nitroxide (1) was attempted with an oil bath temperature of ca. 100°C, rapid decomposition resulted and the hydroxylamine (2) was isolated as the major product. While this initially signalled further mechanistic complexity with regard to the decomposition of the nitroxide (1), subsequent work proved it to be no more than the result of a novel rearrangement of the hydroxylamine (3). This rearrangement first revealed itself during g.l.c. analysis of the products of decomposition of the nitroxide (1). On a KOH/carbowax column at relatively low temperatures (ca. 60°C), the hydroxylamine (3) gave rise to a peak with considerable 'tailing' characteristic of sample decomposition. At higher temperatures (e.g. 100°C), g.l.c. of the hydroxylamine (3) on the same column produced a sharp peak with a retention time identical to that of the isomeric hydroxylamine (2). Indeed, co-injection of

samples of both hydroxylamines produced one discrete peak at ca. 100°C. This provided strong evidence that the hydroxylamine (3) was thermally unstable rearranging exclusively to the hydroxylamine (2). That this thermal instability was not restricted to the environment of a g.l.c. column was established by refluxing a solution of the hydroxylamine (3) in toluene. After a period of 2 hours at ca. 120°C, t.l.c. analysis, using authentic samples for comparison indicated that a proportion of the hydroxylamine (3) had rearranged to its isomer (2). Further refluxing of the solution for 16 hours resulted in complete rearrangement to the hydroxylamine (2). No other products were detected in any significant amounts.

An initial examination of the structural relationship between the two isomeric hydroxylamines (2) and (3) points to a rearrangement simply involving inversion of the dimethylallyl group on nitrogen. In the first analysis, such a rearrangement could occur via a concerted [1,3] -sigmatropic shift<sup>1</sup> involving a transition

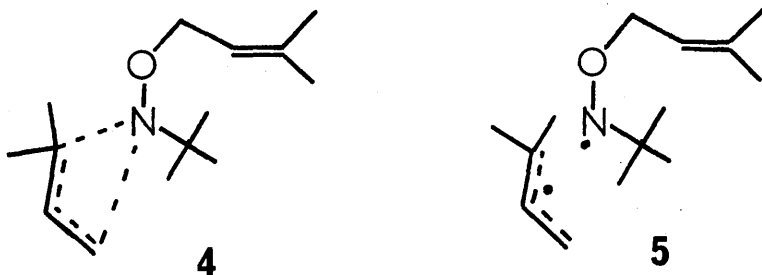

state such as (4) or via the radical pair intermediate (5).

A relatively small number of concerted [1,3] -sigmatropic shifts are known of which probably the most extensively studied, as a result of the elegant work of Berson et. al.<sup>2</sup>, is the rearrangement of endo-bicyclo [3,2,0] -hept-2-en-6-yl

acetate (6) into exo-norbornenyl acetate (7). A [1,3]-

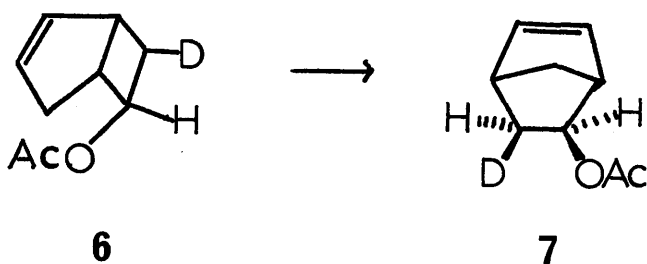

sigmatropic migration of silicon has been observed in the thermal rearrangement of  $\alpha$ -methylallyltrimethylsilane (8) into the  $\gamma$  (crotyl) isomers (9) and (10)<sup>3</sup> and analogous rearrangements have been postulated in the thermolyses of

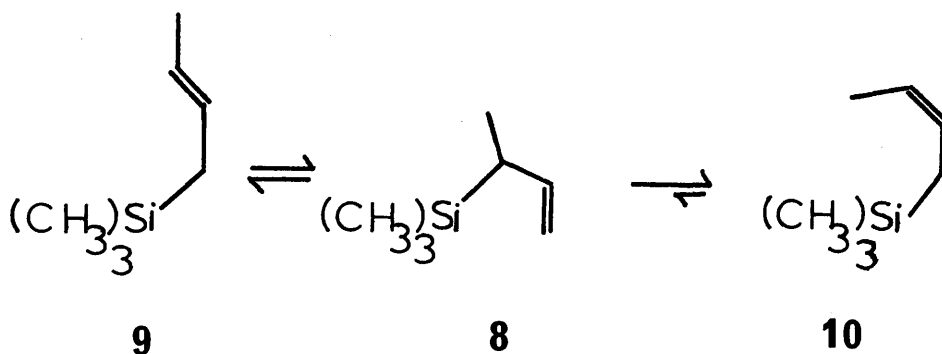

allyl phenyl sulphides<sup>4</sup> and allyl selenides<sup>5</sup>. However, many rearrangements formally considered in this category, such as the vinylcyclopropane-cyclopentene rearrangement<sup>6,7</sup>, proceed with high activation energies (ca. 50 Kcal/mole) and are generally believed to involve diradical intermediates. Thus the vinylaziridine (11) readily undergoes rearrangement to the  $\Delta^3$ -pyrroline (12) at 180°C probably via the hydrazino-diradical (13)<sup>8</sup>. Moreover, in the thermolysis of allylic N-ammonio-amidates, thermolysis of the ylid (14) at 150°C effects rearrangement to (15) by a mechanism

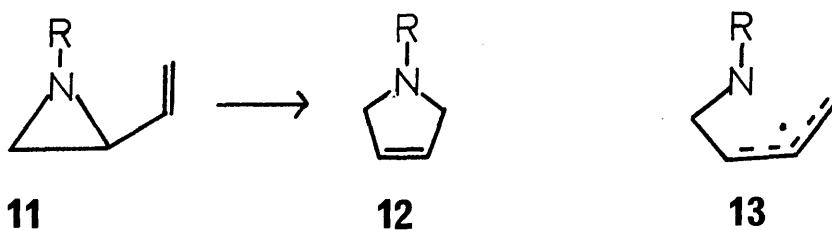

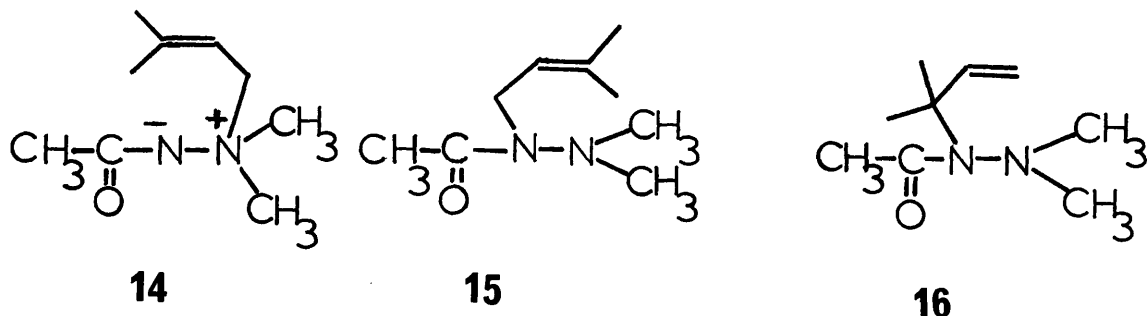

which possibly involves an initial  $[2,3]$ -sigmatropic shift to (16) followed by a homolytic cleavage-recombination to (15)<sup>9</sup>. Evidence for the intervention of a radical pair intermediate in this rearrangement was provided by chemically induced dynamic polarisation (CIDNP)<sup>10,11</sup> in the allylic methylene protons of the developing product during thermolysis<sup>9</sup>.

Undoubtedly one of the major recent advances in the elucidation of certain rearrangement mechanisms has been in the application of CIDNP techniques. Since the initial observations in 1967<sup>12,13</sup> of nuclear polarisation during chemical reactions, the application of this technique has mushroomed at such a rate that many chemical rearrangements have had to be reinterpreted in terms of free radical mechanisms. For example the long-known Stevens rearrangement<sup>14</sup> of ammonium and sulphonium ylids has been the subject of a recent burst of renewed interest. Intramolecularity and retention of configuration in this rearrangement have, until recently, been interpreted as the result of either a concerted reaction or an intimate ion pair intermediate. However CIDNP has been observed during several Stevens rearrangements such as that of the phenacyl ammonium ylid (17) which was

accompanied by a CIDNP effect for the benzyl protons in

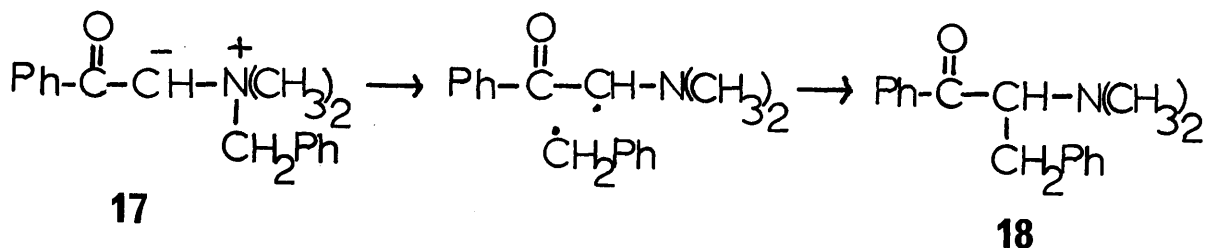

(18)<sup>15</sup>. Despite the radical nature of the intermediates, these rearrangements can occur with considerable retention of stereochemical integrity. For example the ylid (19) undergoes rearrangement to (20) with as much as 95%

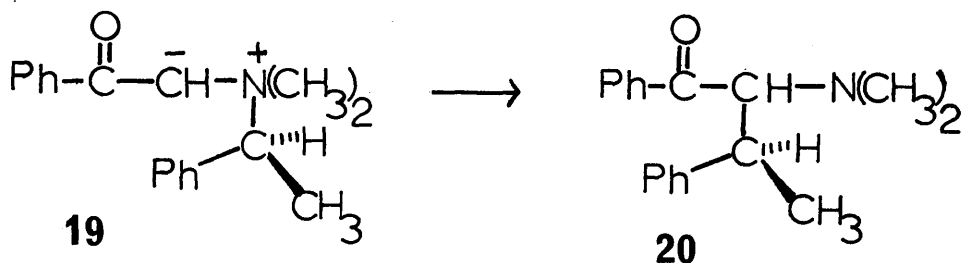

retention of configuration<sup>15</sup>. In an investigation of the rearrangement of the sulphur analogue (21), Baldwin *et. al.*<sup>16</sup> observed polarisation in the product (22) which

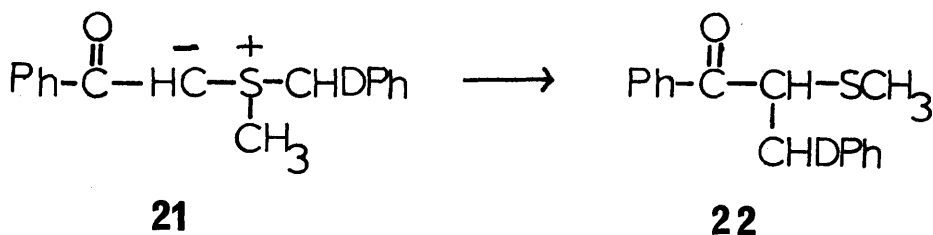

was formed with 36% retention of configuration. Other examples of well-known rearrangements in which CIDNP has greatly aided a mechanistic reappraisal are the Meisenheimer rearrangement of amine oxides<sup>17</sup> and the Martynoff rearrangement of nitrones<sup>18</sup>.



One case in which a CIDNP effect is observed during inversion of a dimethylallyl group on nitrogen is the photolytic rearrangement of the unsymmetric dimethylallyl phenyl azo compound (23) into its isomer (24)<sup>19</sup>. A driving force for such a rearrangement, as will also be

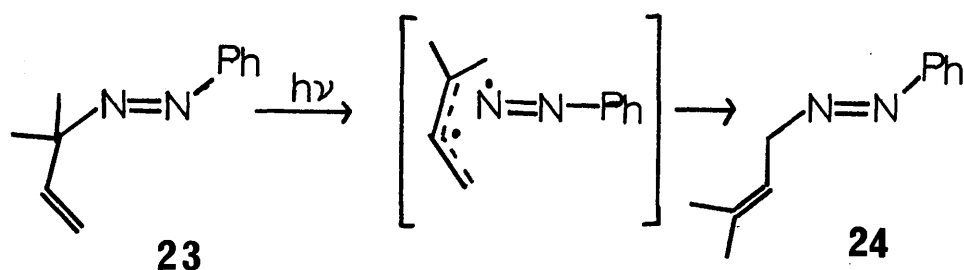

the case for the hydroxylamine (3), is presumably the relief of steric crowding in the reactant relative to the product. However, upon thermolysis of the hydroxylamine (3) no CIDNP effect was observable in the rearranged product (2) formed at 140°C. Thus when a solution of (3) in nitrobenzene was inserted into the n.m.r. probe at 150°C, rapid isomerization to (2) occurred without any detectable polarisation in the methylene protons adjacent to nitrogen or in the vinylic methyl protons. A similar negative result was recorded when the tube was inserted into the probe at 80°C and the temperature increased until rearrangement was rapid. No detectable rearrangement occurred until the temperature of the probe reached ca. 130°C and at 140°C rearrangement was rapid proceeding with  $t_{\frac{1}{2}}$  ca. 6 minutes (CIDNP can be observed in reactions with  $t_{\frac{1}{2}}$  between 30 sec. and 30min.). In each case, the n.m.r. spectrum of (3) gave way cleanly to that of the rearranged product (2). However this negative result did not necessarily invalidate the homolytic

cleavage/recombination pathway since it is always possible that the experimental conditions were, for some reason or other, unsuitable for the detection of polarisation.

One fairly obvious method for detecting free radical intermediates is to perform the rearrangement in the presence of a radical scavenger, although the extent to which scavenging occurs will depend upon cage effects<sup>20</sup> in the rearrangement. In this respect, stable nitroxide radicals have found some application<sup>21</sup>. When a solution of the hydroxylamine (3) and an approximately 2-molar equivalent of the nitroxide (25) in toluene was heated at 140°C, a now rather familiar colour change resulted. After about 10 minutes, the initially red solution rapidly assumed a green/blue colour and a volatile blue compound collected around the base of the condenser. This colour persisted in solution after further heating. After refluxing for a total of 20 minutes, t.l.c. analysis indicated the presence of some nitroxide (25) in addition to a less polar compound with an R<sub>f</sub> value almost identical to that of the starting hydroxylamine (3). Because of the uncertainty as to whether this material was a product or unreacted hydroxylamine (3), the same solution was refluxed for a further 1.5 hours after which time there was no change in the colour or t.l.c. analysis of the solution. This non-polar product was isolated by preparative t.l.c. and found to be a mixture of the hydroxylamines (26) and (27). The hydroxylamine (27) results simply by virtue of the presence of the nitroxide

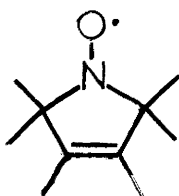

25

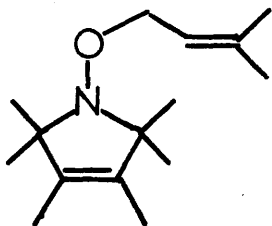

26

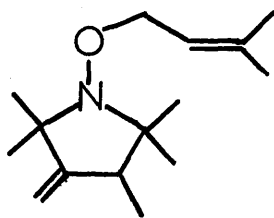

27

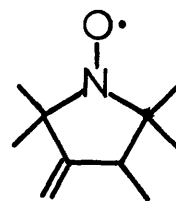

28

(28) as an impurity in (25). As previously discussed in Section I, this impurity arises during the preparation of the corresponding amine. None of the hydroxylamine (2) was detected in the thermolysis product. Use of the nitroxide (29) was found to be more satisfactory from the point of view of purity and when thermolysis of the

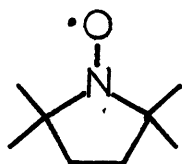

29

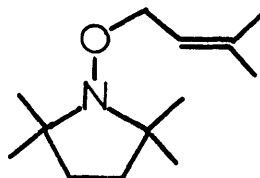

30

hydroxylamine (3) was conducted in the presence of this nitroxide (2 molar equivalent) the hydroxylamine (30) was isolated as the major product. Again, none of the hydroxylamine (2) was detected in the thermolysis product.

These results would seem to indicate that free radicals are indeed involved in the rearrangement of the hydroxylamine (3) and that in the presence of a radical scavenger, (3) gives rise solely to 2-nitroso-2-methylpropane and dimethylallyl radicals which are trapped as the

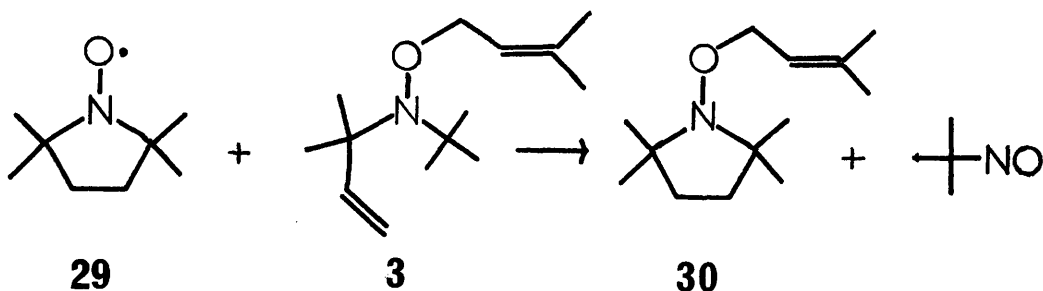

hydroxylamine (30). Consistent with the results of the previous chapter, the dimethylallyl radicals are trapped exclusively via their more reactive primary (tail) positions.

Before proceeding to a discussion of possible mechanisms, the effect of solvent on the rearrangement of (3) warrants some comment. Although consumption of the hydroxylamine (3) in the presence of the nitroxide (25) was complete within 2 hours in refluxing toluene, refluxing a solution of (3) itself in toluene for the same period resulted in only a minor amount of rearrangement to the hydroxylamine (2). Moreover, thermolysis of a solution of the hydroxylamine (3) in toluene at 140°C for 20 minutes effected very little rearrangement whereas thermolysis of a similar solution in nitrobenzene at 140°C for 20 minutes resulted in complete isomerization to the hydroxylamine (2). Thus two important points emerge, first, that the rate of disappearance of the hydroxylamine (3) in refluxing toluene is many times greater in the presence of an added nitroxide and secondly that the rate of isomerization of hydroxylamine (3) to (2) at 140°C is much faster in nitrobenzene than in toluene. This latter result suggests that the rate of isomerization is dependent upon the solvent polarity which may be of importance in the stabilization of polar intermediates (dielectric

constants of toluene and nitrobenzene are 2.39 and 37.72 respectively.). As will be discussed later, rearrangement in dimethylformamide proceeded at a rate similar to that in nitrobenzene as solvent (dielectric constant of dimethylformamide is 37).

In mechanistic terms, possibly the most obvious rationalisation is in terms of an initial thermally-induced cleavage of the hydroxylamine (3) into the radical pair (5) *i.e.* a dimethylallyl and an N-alkoxy-N-alkylamino radical. In the absence of any radical scavenger this

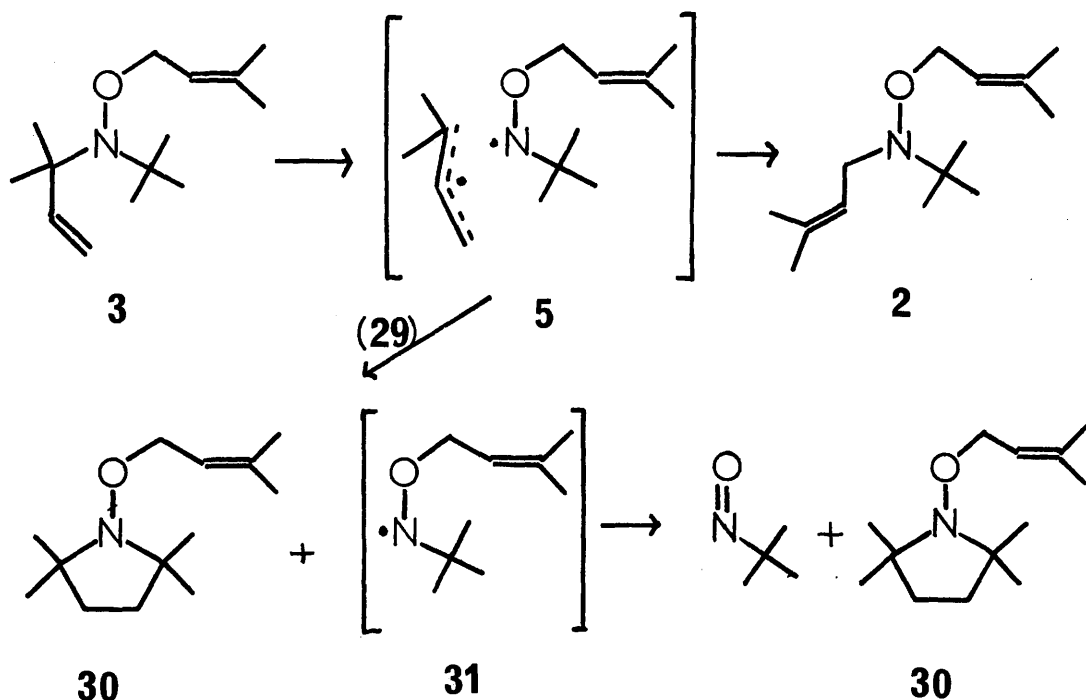

radical pair would simply recombine in the sterically more favoured sense to form the hydroxylamine (2). However, in the presence of the nitroxide (29), the dimethylallyl radical from (5) is trapped (again in the sterically more favoured sense) leaving the N-alkoxy-N-alkylamino radical (31) whose possible intermediacy in the decomposition of the nitroxide (1) has been discussed

in the preceding chapter. Once again, we are in the position of having to propose that this, as yet unexplored, species (31) fragments to a dimethylallyl radical and 2-nitroso-2-methylpropane. Subsequent trapping of the dimethylallyl radical by nitroxide would yield another molecule of the hydroxylamine (30). While this mechanism might explain the overall results, it does not accommodate particularly well the finding that in toluene, the rate of consumption of (3) is much faster in the presence of the nitroxide scavenger. The observed influence of solvent could be explained in terms of solvation of the polar intermediate N-alkoxy-N-alkylamino radical (31) and in

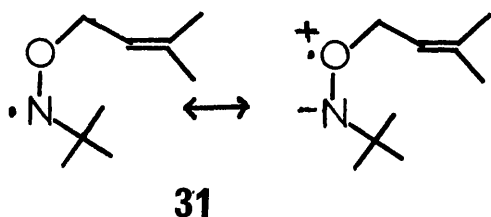

this respect possibly the rate enhancement observed in the presence of a nitroxide ( $\mu = 3.14\text{D}^{22}$ ) is a result of an increase in the polarity of the medium.

In contemplating other possible mechanisms, it is relevant to consider the results of Hoffmann *et. al.*<sup>23</sup> on the thermal properties of the tri-*t*-butyl hydroxylamine (32). These workers found that the C-O bond in (32)

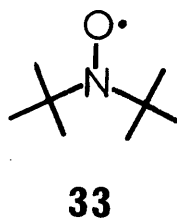
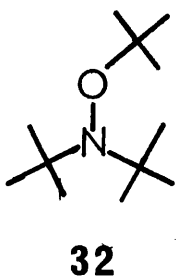

was thermally labile and that on thermolysis of this compound at 150°C, di-*t*-butyl nitroxide (33) was produced (25% yield). Therefore with respect to the hydroxylamine (3), another possible mechanism could involve initial homolysis of the C-O bond forming a dimethylallyl radical and the nitroxide (1). Under the conditions of

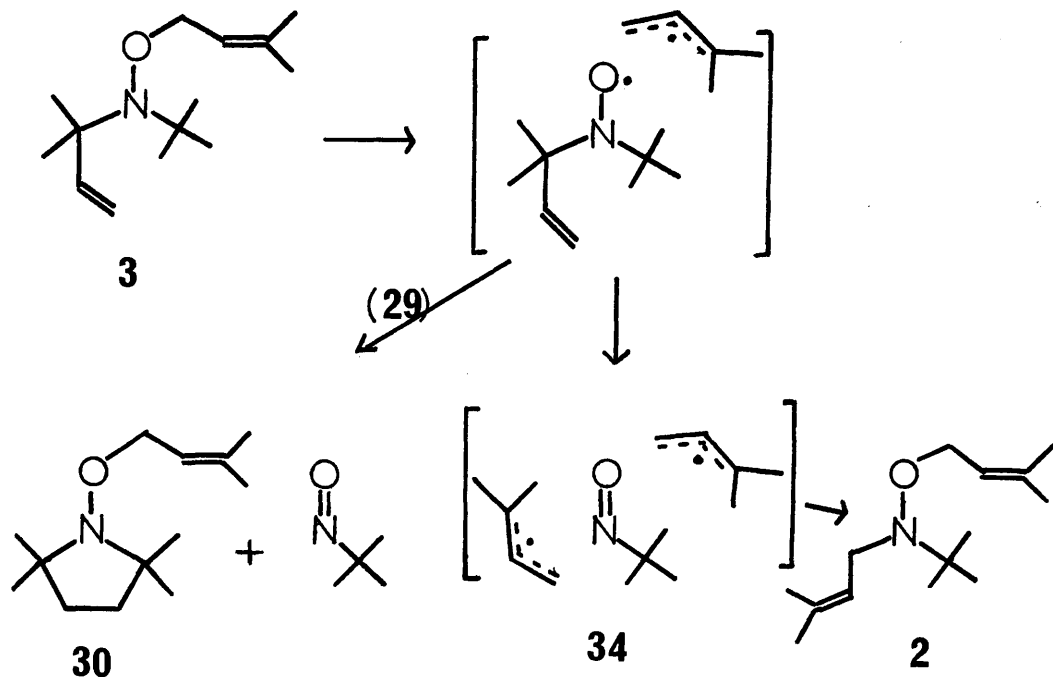

rearrangement, this nitroxide would be very short-lived decomposing to another dimethylallyl radical and 2-nitroso-2-methylpropane. In the presence of the stable nitroxide (29), both fragmentation steps would lead obviously to the hydroxylamine (30) and the nitroso compound. However, in the absence of the radical scavenger, we have somewhat reluctantly to propose that the three-component intermediate (34) would collapse cleanly to the hydroxylamine (2). The rate dependence on the solvent and on the presence or absence of added nitroxide could be explained, as in the previous mechanism, by stabilizing effects on the polar radical formed, in this case the nitroxide (1).

One further mechanism could be proposed which involves the lone pair of electrons on oxygen in a [2,3]-sigmatropic rearrangement (see Chapter 1 of this Section) to form the intermediate ylid (35). Sigmatropic rearrangements

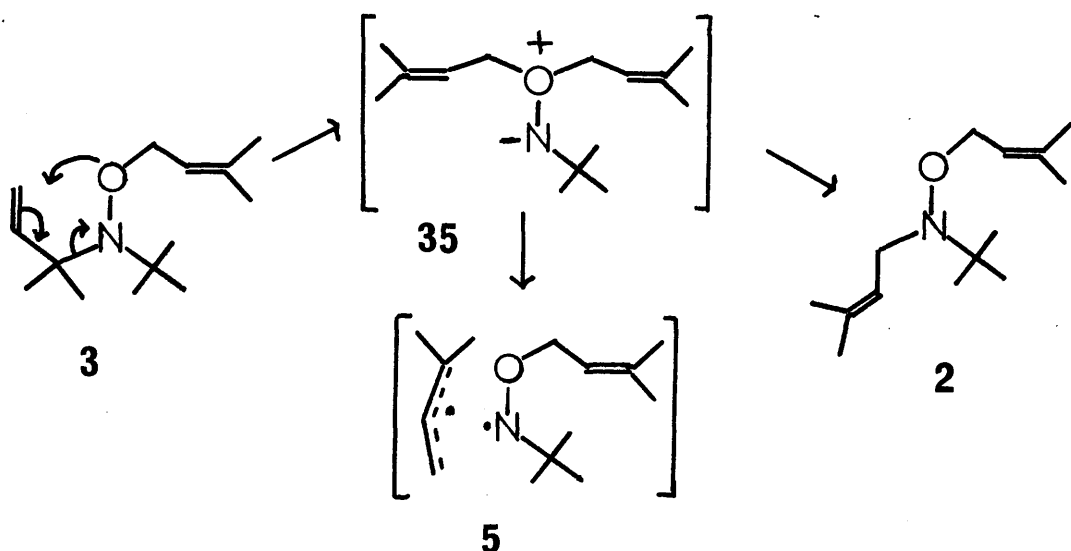

such as this are, as yet, unreported in hydroxylamine chemistry. Nor have species such as the aminooxonium ylid (35) been reported. However by analogy with the chemistry of other known ylids, such as the ammonium and sulphonium ylids mentioned earlier in this discussion, this species (35) might be expected to undergo a [1,2] shift via free radical intermediates to form the hydroxylamine (2). Any added nitroxide radical could interrupt this process by trapping the dimethylallyl radical leaving the N-alkoxy-N-alkylamino radical which might fragment in the manner previously discussed. This mechanism has the advantage that the formation of the dipolar species (35) satisfactorily explains the observed influence of solvent polarity.

Having been presented with three possible mechanistic



rationalisations, the reader will doubtless now be aware of the potential complexity of this seemingly simple rearrangement. One of the complexing factors was the influence which an added nitroxide radical had on the rate of consumption of the hydroxylamine (3) and the following experiment was conducted to determine whether or not the added nitroxide brought about decomposition of (3) via an unrelated mechanism. Thus a solution of the apparently thermally stable hydroxylamine (30) and a 2-molar equivalent of the nitroxide (36)<sup>24</sup> in nitrobenzene was heated at ca. 140°C for 20 minutes. The results of this experiment did indeed prove to be informative. T.l.c. analysis with comparison to the authentic material indicated the formation of the nitroxide (29) while preparative t.l.c. allowed the isolation of the hydroxylamine (37). It was therefore apparent that,

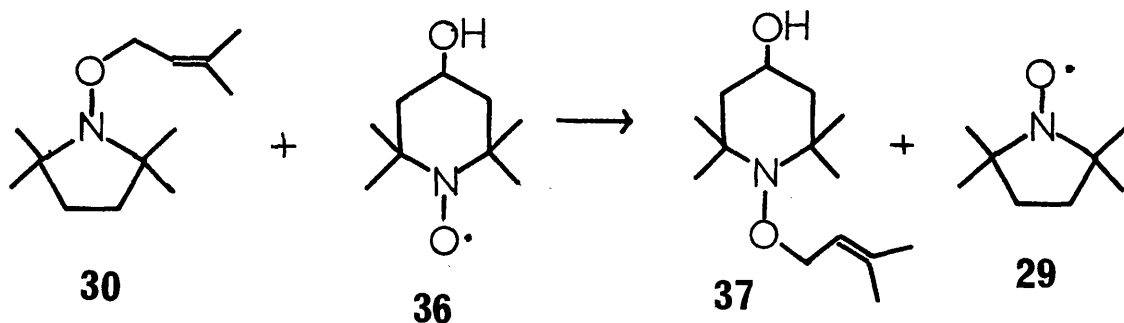

under these conditions, transfer of a dimethylallyl group from the hydroxylamine (30) to the nitroxide (36) was taking place. Without involving too much mechanistic speculation, this result would seem to corroborate the results of Hoffmann et. al.<sup>23</sup>, i.e. that the C-O bond in these hydroxylamines is thermally labile. Thermolysis of the hydroxylamine (30) at 140°C may result in C-O bond cleavage but not decomposition of the hydroxylamine

since, to the radical fragments formed, there is no viable alternative to recombination. However, when thermolysis of the hydroxylamine occurs in the presence of an added nitroxide such as (36), there exists a viable alternative in that the dimethylallyl radical can be trapped by nitroxide (36) thereby resulting in transfer of a dimethylallyl group.

One definite conclusion drawn from this experiment was that, with respect to the rearrangement of the hydroxylamine (3), the use of a nitroxide radical scavenger represented something of a red herring. Far from being an aid to the elucidation of the mechanism of rearrangement of (3), the use of an added nitroxide had provided an irrelevant, albeit interesting diversion.

A more fruitful approach proved to be via the use of deuterium labelling. If rearrangement of (3) occurs in the simplest sense viz. by straightforward homolytic cleavage-recombination (as shown below) then nitrogen recombines with the same dimethylallyl group. Similarly

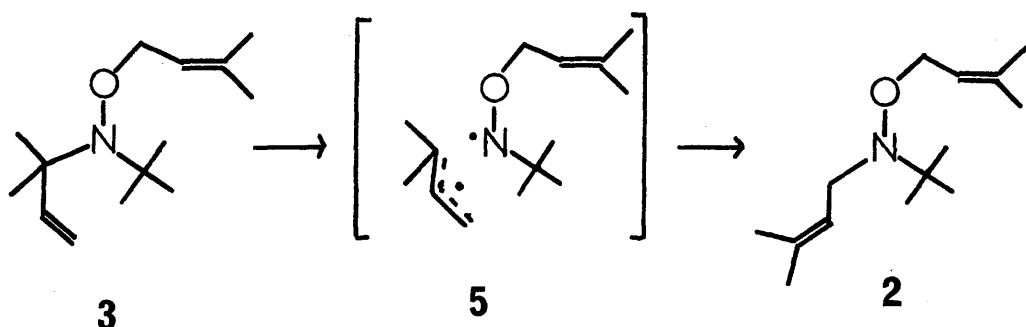

if a  $[1,3]$  -sigmatropic shift is involved, the same dimethylallyl group remains on nitrogen. However, if rearrangement involves an initial  $[2,3]$  -sigmatropic

shift to generate the intermediate ylid (35), scrambling of the dimethylallyl groups can occur since the ylid (35)

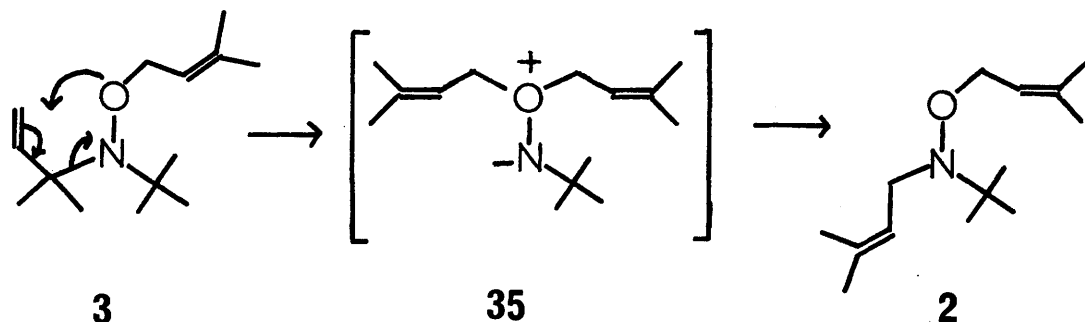

is essentially symmetrical about the N-O bond and either dimethylallyl group can migrate to form the product (2). It was therefore considered that thermolysis of the labelled hydroxylamine (38) would be interesting since the distribution of deuterium in the product would confirm whether or not scrambling of the dimethylallyl groups

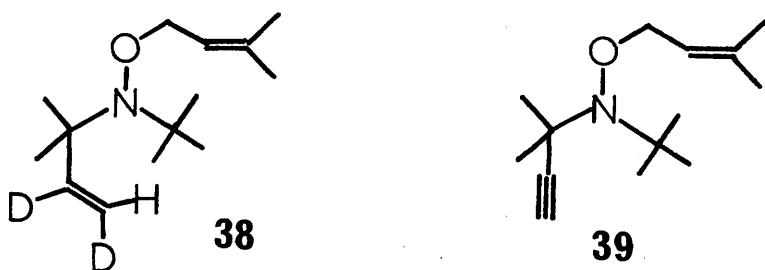

was occurring during rearrangement. The most convenient method of preparation of (38) appeared to be by catalytic reduction of the acetylenic hydroxylamine (39) with deuterium. The simplest route to the hydroxylamine (39) seemed to be by the generation of dimethylallyl radicals in the presence of the acetylenic nitroxide (40). We considered two possibilities for this process; (a) relatively low temperature thermolysis of the azo compound (41) in the presence of the nitroxide (40) and (b) room

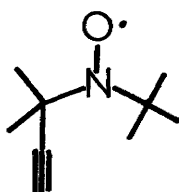

40

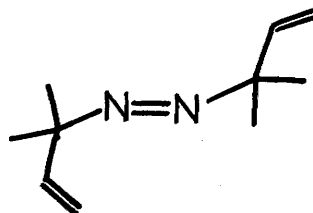

41

temperature decomposition of the nitroxide (1) in the presence of (40). In the event the latter method was chosen since, <sup>at the</sup> lower temperature required, decomposition of the nitroxide (40) would not present such a serious problem. Thus when a solution of the nitroxides (40) and (1) (ratio ca. 4:3 respectively) in benzene was allowed to stand at room temperature under an inert atmosphere for 4-5 days, one of the major products, isolated by preparative t.l.c., was the required hydroxylamine (39) (ca. 30% yield based on acetylenic

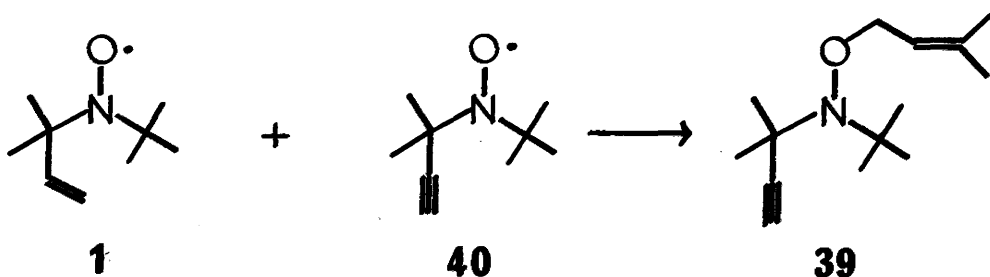

nitroxide (40)). Another major component of this complex decomposition mixture proved to be the hydroxylamine (3).

Considerable experimentation was required in order to effect an efficient reduction of (39) to (3). Lindlar catalyst proved to be totally ineffective in the hydrogenation of (39). While 10% palladium on charcoal was an effective catalyst, the reduction proved to be extremely

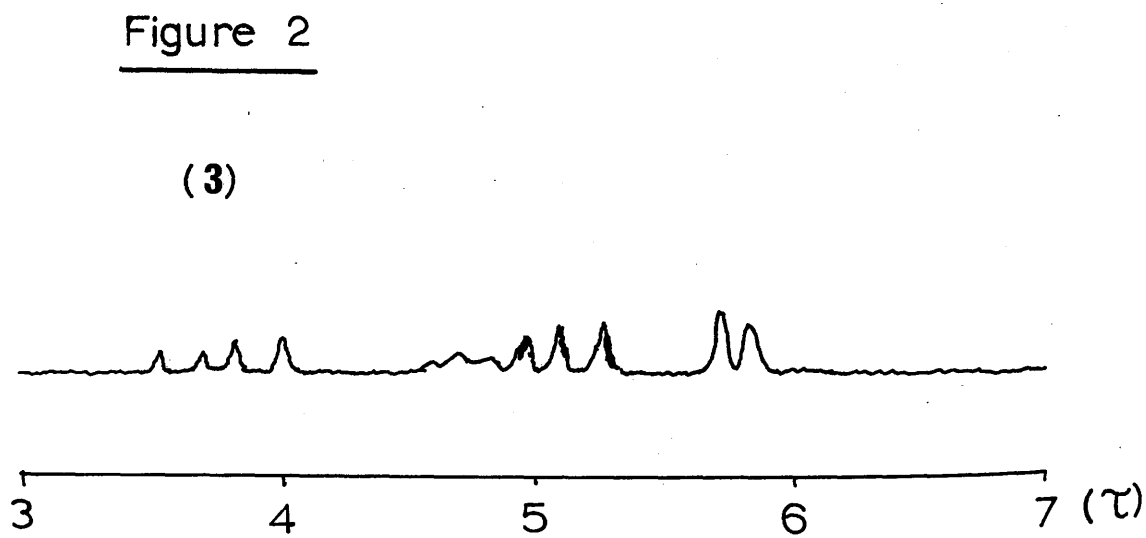
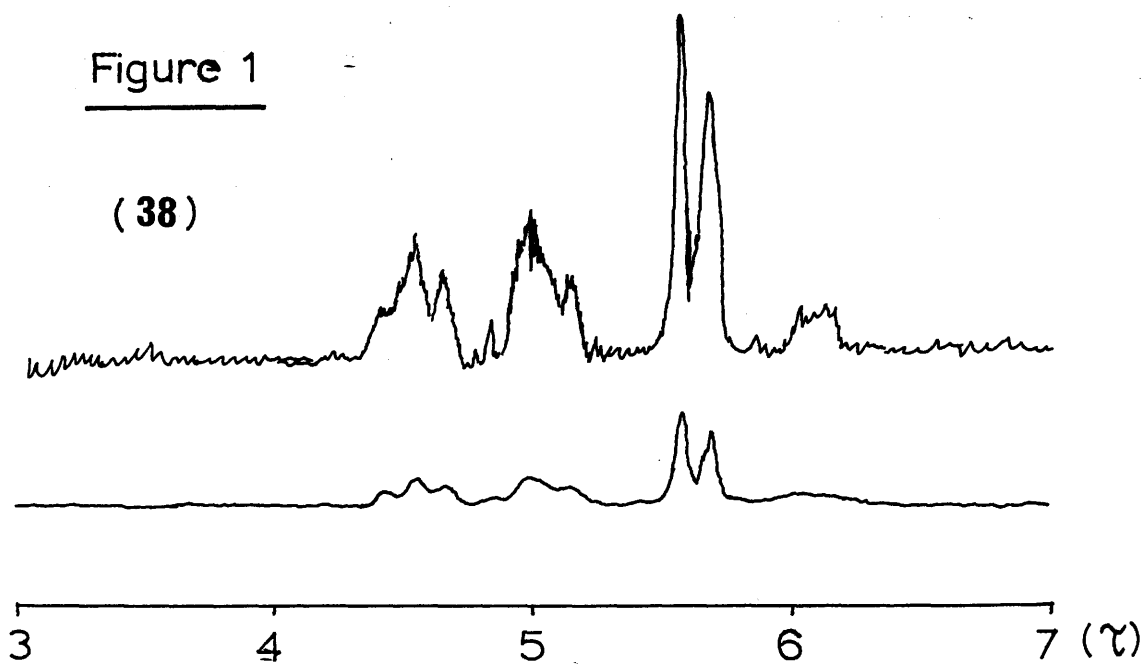

sensitive to the quantities of catalyst and solvent, the rate of stirring and the overall dimensions of the vessel. Once conditions for the conversion of (39) to (3) had been established, the reduction was carried out with deuterium generated electrolytically from a solution of  $D_2SO_4$  in  $D_2O$ . The n.m.r. spectrum (60 MHz.) of this labelled hydroxylamine (38) is shown in Fig. 1 while that of the unlabelled hydroxylamine (3) is shown in Fig. 2. The proton  $H_1$  in (38) displays a complex

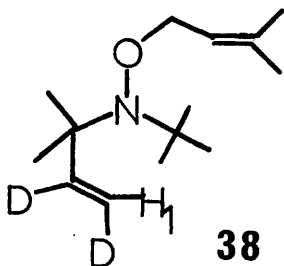

multiplet as a result of coupling to the two deuterium atoms. It was particularly reassuring to note that no significant isotopic exchange of the vinylic methyl protons had occurred on reduction (exchange of allylic hydrogens can occur in the presence of metal catalysts<sup>25</sup>).

Having thus prepared the labelled hydroxylamine (38) it was, on paper, a simple matter to effect its thermolysis in nitrobenzene solution and to examine the distribution of deuterium in the product. However, a problem was encountered in attempting to isolate the labelled rearranged hydroxylamine (42) free of nitrobenzene. Both compounds had similar  $R_f$  values on preparative t.l.c. and even

Figure 3

(42)

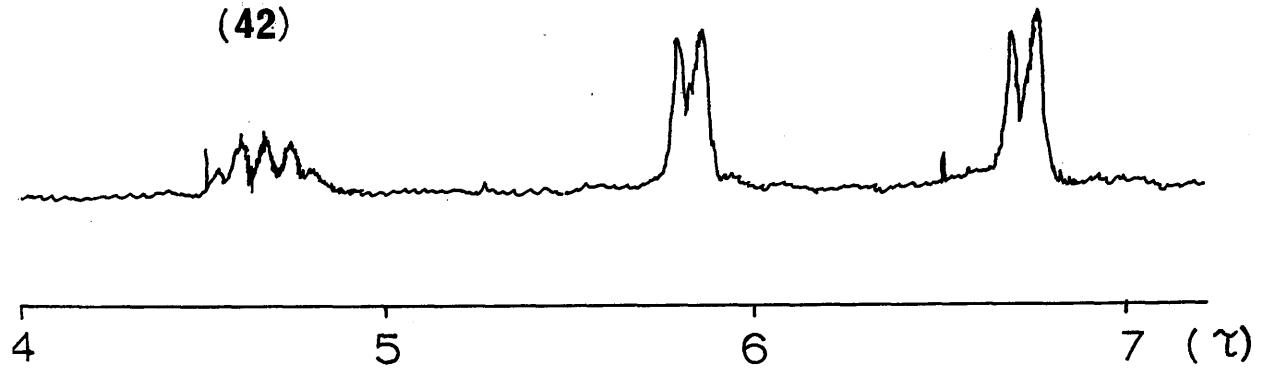
Figure 4

(2)

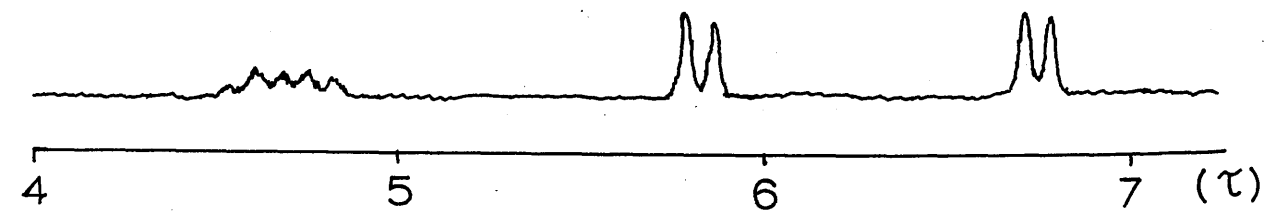

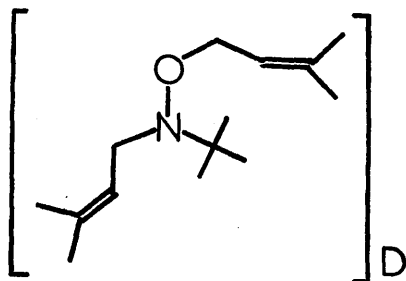

42

using a sulpholane/petroleum ether extraction method, the product (42) was always contaminated with nitrobenzene. For this reason it was decided to attempt the thermolysis in dimethylformamide (DMF) since the high water solubility of this solvent would render it easily separable from the product (42). In a trial experiment, it was found that thermolysis of a solution of the hydroxylamine (3) in DMF at 140°C for 20 minutes resulted in complete conversion to the rearranged material (2). Similarly, thermolysis of the labelled material (38) afforded the rearranged product (42) which was isolated in a pure state. The n.m.r. spectrum (100 MHz.) of this product is shown in Fig. 3 and its comparison with that of the unlabelled hydroxylamine (2) (Fig. 4) reveals a most interesting result. The relative intensities of the doublets at  $\tau = 5.83$  (C=C-CH<sub>2</sub>-O) and 6.73 (C=C-CH<sub>2</sub>-N) in the labelled product (42) (Fig. 3) are similar (ca. 1:1). Moreover, these resonances show similar broadening owing to coupling to deuterium in relation to the unlabelled hydroxylamine (2) (Fig. 4). Therefore the distribution of deuterium in the rearranged product is virtually equal between the dimethylallyl groups attached to nitrogen and oxygen. Hence concomitant scrambling of the



dimethylallyl groups must be occurring during rearrangement of the hydroxylamine (3).

In mechanistic terms, this result precludes a rearrangement which involves only simple homolytic cleavage/recombination or only a concerted [1,3]-sigmatropic shift.

Nevertheless, while having ruled out these two possibilities, we are still left with a number of mechanistic alternatives. Clearly compatible with these results is the mechanism proposed to involve an initial [2,3]-sigmatropic shift generating the symmetrical ylid (35).

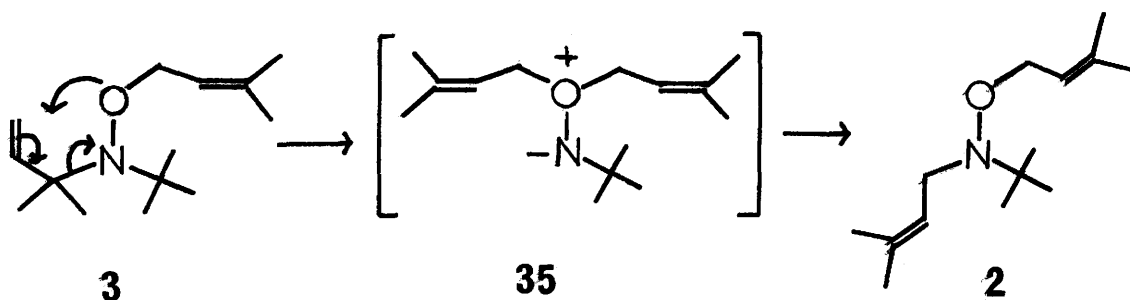

Subsequent migration of a dimethylallyl group would involve scrambling of the deuterium label in the product (2).

The ylid (35) is not the only possible symmetrical intermediate which can accommodate the observation of scrambling of the dimethylallyl groups. The three-component intermediate (34) is essentially symmetrical with respect to the dimethylallyl groups and stepwise

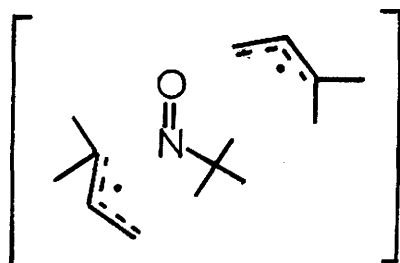

recombination in the sterically more favoured sense could afford the hydroxylamine (2) with the required scrambling of dimethylallyl groups. Such a mechanism is considered to be less likely particularly since the results of the previous chapter indicate that 2-nitroso-2-methylpropane is not a good trapping agent for dimethylallyl radicals. Another factor mitigating against the possible intermediacy of (34) is the fact that no detectable amounts of C<sub>10</sub> hydrocarbon coupling products and 2-nitroso-2-methylpropane are formed in the rearrangement. It might have been expected that combination of dimethylallyl radicals to form C<sub>10</sub> hydrocarbon dienes would be a significant mode of reaction of the intermediate (34).

It would appear that the only other way of reaching what is tantamount to a symmetrical intermediate is to consider a dual mechanism. For example, the deuterium scrambling could be explained by a reaction in which 50% of the product arose via simple homolysis/recombination (intermediate (5)) and 50% arose via a mechanism such as the one described below involving an intermediate amine oxide (43). However, it would be surprising to find that

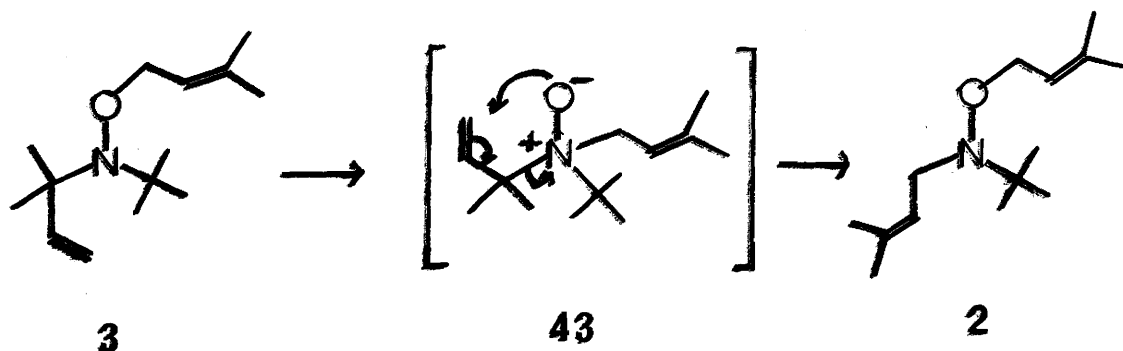

the ratio of products arising from two such dissimilar mechanisms was exactly 50:50.

It was considered that some light might be shed on the problem by a knowledge of the distribution of deuterium in the product (42) (viz. the percentage, if any, of  $d_0$  and  $d_4$  species). Normally this information can be readily obtained from the mass spectrum. Unfortunately, this was thwarted by the apparent instability of the hydroxylamines (2) and (3) in the mass spectrometer. In both cases, it was not possible to observe a molecular ion peak under a variety of conditions of source temperature and ionization voltage and always the highest peak corresponded to an  $[M-68]^+$  ion. This fragmentation behaviour, which is well known in the chemistry of dimethylallyl aromatic ethers such as (44)<sup>26</sup> probably arises via

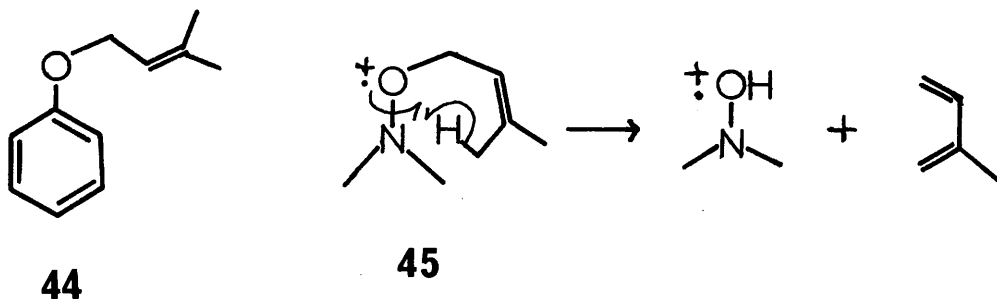

a  $\gamma$ -hydrogen abstraction mechanism involving the transition state (45)<sup>27</sup> and resulting in the loss of isoprene.

With the present state of knowledge regarding this hydroxylamine rearrangement it is not possible to predict safely by what mechanism it occurs. The most satisfactory explanation so far appears to be that involving a  $[2,3]$ -sigmatropic shift to form the intermediate ylid (35) since

it readily accounts for the dimethylallyl scrambling and the observed influence of solvent polarity. However, the lack of any close analogy for this scheme underlines its speculative nature. Further work would be required to determine if, in fact, ylids such as (35) undergo rearrangement to trialkylhydroxylamines. Moreover, a detailed analysis of the kinetics of this rearrangement, with an evaluation of the entropy of activation, might prove useful in establishing whether or not the rate-determining step involves a cyclic transition state.

Possibly the only definite conclusion which can be reached at this stage is that this excursion beyond the frontiers of preparative organic chemistry has exposed a mechanistic complexity scarcely imagined from a cursory consideration of this 'simple' rearrangement.

EXPERIMENTAL.

Studies on the thermal rearrangement of  $\underline{N}$ -(1,1-dimethylallyl)- $\underline{O}$ -(3,3-dimethylallyl)- $\underline{N}$ - $t$ -butylhydroxylamine (3) to  $\underline{N},\underline{O}$ -di (3,3-dimethylallyl)- $\underline{N}$ - $t$ -butylhydroxylamine (2).

1. Thermolysis in refluxing toluene.

A solution of  $\underline{N}$ -(1,1-dimethylallyl)- $\underline{O}$ -(3,3-dimethylallyl)- $\underline{N}$ - $t$ -butylhydroxylamine (3) (14mg.) in toluene (1ml.) was refluxed for a period of 2 hours. Subsequent analysis of the solution by t.l.c. (5% ether/60-80 petroleum ether), using authentic samples for comparison, revealed that a proportion of the starting hydroxylamine had rearranged to its isomer,  $\underline{N},\underline{O}$ -di-(3,3-dimethylallyl)- $\underline{N}$ - $t$ -butylhydroxylamine (2). This same solution was then refluxed for a further period of 16 hours and t.l.c. analysis of the product solution indicated complete conversion of the starting hydroxylamine (3) to its isomer (2). Apparently, no other products were produced in significant amounts.

2. Attempted detection of CIDNP during thermolysis.

A solution of  $\underline{N}$ -(1,1-dimethylallyl)- $\underline{O}$ -(3,3-dimethylallyl)- $\underline{N}$ - $t$ -butylhydroxylamine (3) (50mg.) in redistilled nitrobenzene (0.4 ml.) and tetramethylsilane (2 drops) was sealed in an n.m.r. tube. The tube was inserted into the variable-temperature probe which was preheated to 150°C and the spectrum rapidly scanned from 3 to 9  $\tau$  repeatedly but neither signal enhancement nor emission was observed. At this temperature, rearrangement was rapid and essentially complete within about 10 minutes.

In a second experiment, a solution of the hydroxylamine

(3) (50mg.) and tetramethylsilane (2 drops) in nitrobenzene (0.3ml.) in a sealed n.m.r. tube was inserted into the probe set at 80°C. After temperature equilibration, the n.m.r. spectrum was that of the starting hydroxylamine (3), no detectable rearrangement having occurred. The probe temperature was raised by various increments until rearrangement was apparent. Thus the spectrum (3-9 $\tau$ ) was run at 110°, 120° until, at ca. 140°, rearrangement was rapid. Repeated rapid scans at 130-140° were made but neither signal enhancement nor emission was observed. At 140°C rearrangement was rapid with  $t_{\frac{1}{2}}$  ca. 6 minutes.

Similarly in a third experiment, the tube was pre-heated with hot air from an air gun (to reduce the temperature equilibration time) and inserted into the probe set at 145°C. The spectrum was scanned rapidly between 3 and 7.5 $\tau$  (each scan taking about 15 secs.) and the rapid conversion of the hydroxylamine (3) to its isomer (2) was observed. However, again no CIDNP effect was observed.

### 3. Thermolysis in the presence of 2,2,3,4,5,5-hexamethylpyrroline-1-oxyl (25).

A solution of N-(1,1-dimethylallyl)-O-(3,3-dimethylallyl)-N-t-butylhydroxylamine (3) (50mg.) and 2,2,3,4,5,5-hexamethylpyrroline-1-oxyl (25) (60mg.) in toluene (2ml.) was heated at 140°C. After approximately 10 minutes the initially red solution assumed a green/blue colour and a volatile blue compound was seen to be collecting around the base of the condenser. This colour persisted on further refluxing and after a total of 20 minutes, the solution by t.l.c. (5% ether/60-80

petroleum ether) showed two spots; a major one (actually two closely running spots) with an  $R_f$  value almost identical to the starting hydroxylamine (3) and a minor one corresponding to the nitroxide (25). At this stage it was mistakenly thought that the major spot corresponded to unreacted starting hydroxylamine. Therefore the same solution was heated at  $140^\circ\text{C}$  for a further 1.5 hours after which time there was no visible change in either the colour or the t.l.c. analysis of the solution. Preparative t.l.c. (5% ether/60-80 petroleum ether) allowed the isolation of the major component as a colourless oil (57.1 mg.). Careful analytical t.l.c. (5% ether/60-80 petroleum ether) revealed that this product gave rise to two closely running spots whose  $R_f$  values did not alter on varying the solvent system or on multiple elution. The n.m.r. spectrum of this product was consistent with a mixture of 1-(3,3-dimethylallyloxy)-2,2,3,4,5,5-hexamethylpyrroline (26) and 1-(3,3-dimethylallyloxy)-3-methylene-2,2,4,5,5-pentamethylpyrrolidine (27).

In a number of control experiments monitored by t.l.c., it was found that first, heating a solution of 2,2,3,4,5,5-hexamethylpyrroline-1-oxyl (25) (10mg.) in toluene (1 ml.) at  $140^\circ\text{C}$  for 20 minutes resulted in no reaction whatsoever. Secondly, heating a solution of N-(1,1-dimethylallyl)-O-(3,3-dimethylallyl)-N-*t*-butylhydroxylamine (3) (10mg.) in toluene (1ml.) at  $140^\circ\text{C}$  for 20 minutes resulted in only a minor amount of the rearranged material being formed. Thirdly, heating a solution of N-(1,1-dimethylallyl)-O-(3,3-dimethylallyl)-N-*t*-butylhydroxylamine (3) (10mg.) in nitrobenzene (1ml.) at  $140^\circ\text{C}$  for 20 minutes resulted in complete rearrangement to the isomeric hydroxylamine (2).

4. Thermolysis in the presence of 2,2,5,5-tetramethylpyrrolidine-1-oxyl (29).

A solution of N-(1,1-dimethylallyl)-O-(3,3-dimethylallyl)-N-t-butylhydroxylamine (3) (50mg.) and 2,2,5,5-tetramethylpyrrolidine-1-oxyl (29) (63mg., 2 molar equivalent) in nitrobenzene (1ml.) was heated at 140°C. After approximately 5 minutes the initially yellow solution turned to an emerald green colour which faded a little on continued heating. After a total of 20 minutes, the solution was allowed to cool and subsequently transferred to a separating funnel. Sulpholane (5ml.) and petroleum ether (10ml., 40-60) were added and, after thorough extraction the petroleum ether layer was removed. The sulpholane portion was re-extracted with petroleum ether (10ml.) and the petroleum ether extracts combined. The petroleum ether was carefully removed under reduced pressure to leave a yellow coloured oil with an odour indicative of the presence of some nitrobenzene. T.l.c. analysis (5% ether/60-80 petroleum ether) of this product indicated that the major component was relatively non-polar with an  $R_f$  value similar to that of the starting hydroxylamine (3). Preparative t.l.c. of this product in the same solvent system allowed isolation of this material as a colourless oil (44.7mg.). This product was characterized as 1-(3,3-dimethylallyloxy)-2,2,5,5-tetramethyl-pyrrolidine (30).

$\nu_{\text{max}}$ . (liquid film) = 3050, 1680, 1460, 1380, 1360, 1320, 1200, 1180 and 1030cm.<sup>-1</sup>

$\tau$ (CDCl<sub>3</sub>) = 8.83 (12H, singlet), (CH<sub>3</sub>)<sub>2</sub>-C-N, 8.40 (4H, singlet), -CH<sub>2</sub>-CH<sub>2</sub>-, 8.30 and 8.23 (both 3H, broadened singlets), (CH<sub>3</sub>)<sub>2</sub>-C=C, 5.71 (2H, broad doublet, J=8Hz.),



$-O-\underline{CH_2}-CH=$ , 4.55(1H, broad triplet,  $J=8\text{Hz}$ ),  $-O-\underline{CH_2}-\underline{CH=}$

Analysis; Found : C, 73.69; H, 11.84; N, 6.69%.

$C_{13}H_{25}NO$  Requires : C, 73.88; H, 11.92; N, 6.63%.

Thermolysis of 1-(3,3-dimethylallyloxy)-2,2,5,5-tetramethylpyrrolidine (30) in the presence of 4-hydroxy-2,2,6,6-tetramethylpiperidine-1-oxyl (36).

A solution of 1-(3,3-dimethylallyloxy)-2,2,5,5-tetramethylpyrrolidine (30) (50mg.) and 4-hydroxy-2,2,6,6-tetramethylpiperidine-1-oxyl (36)<sup>28</sup> (81.5mg., 2 molar equivalent) in nitrobenzene (1ml.) was heated at 135-140°C for 20 minutes. After transferring the solution to a separating funnel, sulpholane (5ml.) was added and the solution extracted with petroleum ether (40-60, 2x15ml.). The petroleum ether extracts were washed with water (5ml.) and the petroleum ether carefully removed under reduced pressure to yield a yellow coloured oil (contaminated with some nitrobenzene). T.l.c. analysis (30% ether/60-80 petroleum ether) revealed three major components; one non-polar compound ( $R_f$  ca. 0.8), a compound ( $R_f$  ca. 0.3) which, by comparison with an authentic sample, was identified as 2,2,5,5-tetramethylpyrrolidine-1-oxyl (29) and a polar compound ( $R_f$  ca. 0.1). T.l.c. analysis (5% ether/60-80 petroleum ether) indicated that virtually all the starting hydroxylamine (30) had been consumed. The non-polar product was not identified but preparative t.l.c. (30% ether/60-80 petroleum ether) allowed the isolation of the polar product as a colourless oil (35mg.). This compound was identified as 1-(3,3-dimethylallyloxy)-4-hydroxy-2,2,6,6-tetramethylpiperidine (37).

$\nu_{\text{max}}$ . (liquid film) = 3350 (broad), 1680, 1460, 1380,

1360, 1260, 1180, 1040 and 900cm.<sup>-1</sup>

$\tau(\text{CDCl}_3) = 8.83$  (6H, singlet)  $\text{CH}_3\text{-C-N}$ , 8.75 (6H, singlet),  $\text{CH}_3\text{-C-N}$ , 8.54 (1H, broad singlet, slow exchange with  $\text{D}_2\text{O}$ ),  $\text{-OH}$ , 8.31 and 8.22 (both 3H, broadened singlets),  $(\text{CH}_3)_2\text{-C=C}$ , 5.80-6.30 (1H, multiplet),  $\text{-CH-OH}$ , 5.68 (2H, broad doublet,  $J=7\text{Hz.}$ ),  $\text{-CH}_2\text{-CH=C}$ , 4.59 (1H, broad triplet,  $J=7\text{Hz.}$ ),  $\text{-CH}_2\text{-CH=C}$ .

Analysis; Found : C, 69.78; H, 11.99; N, 5.73%

$\text{C}_{14}\text{H}_{27}\text{NO}_2$  Requires: C, 69.67; H, 11.27; N, 5.80%

$\text{N-(1,1-dimethylpropargyl)-O-(3,3-dimethylallyl)-N-t-butylhydroxylamine (39)}$ .

A solution of  $\text{N-(1,1-dimethylpropargyl)-N-t-butylaminoxyl (40)}$  (ca. 400mg.) and  $\text{N-(1,1-dimethylallyl)-N-t-butylaminoxyl (1)}$  (ca. 300mg.) in benzene (6ml.) was thoroughly degassed in a stream of oxygen-free nitrogen and then allowed to stand at room temperature under a positive pressure of nitrogen for a period of 4.5 days. T.l.c. analysis (5% ether/60-80 petroleum ether) of the then greenish blue solution revealed a complex array of spots. However, the two major, relatively non-polar, products were of interest. The least polar component ( $R_f$  ca. 0.6) was found to correspond to  $\text{N-(1,1-dimethylallyl)-O-(3,3-dimethylallyl)-N-t-butylhydroxylamine (3)}$  by comparison with an authentic sample while the next least polar compound ( $R_f$  ca. 0.5) was found to correspond to the desired product (39). Thus preparative t.l.c. (5% ether/60-80 petroleum ether) yielded the title compound as a colourless oil (133mg., 30% yield relative to 40).

$\nu_{\text{max}}$ . (liquid film) = 3330, 1680, 1460, 1380, 1360, 1220, 1170 and 1020  $\text{cm}^{-1}$

$\tau(\text{CDCl}_3)$  = 8.67 (9H, singlet),  $(\text{CH}_3)_3\text{-C-N}$ , 8.44 (6H, singlet),  $(\text{CH}_3)_2\text{-C-N}$ , 8.32 and 8.24 (both 3H, broadened singlets),  $(\text{CH}_3)_2\text{-C=C}$ , 7.66 (1H, singlet),  $\text{-C}\equiv\text{CH}$ , 5.65 (2H, broad doublet,  $J = 7\text{Hz.}$ ),  $\text{-O-CH}_2\text{-CH-}$ , 4.60 (1H, broad triplet,  $J=7\text{Hz.}$ ),  $\text{-O-CH}_2\text{-CH=C}$ .

Analysis: Found ; C, 75.56; H, 11.39; N, 6.20%.

$\text{C}_{14}\text{H}_{25}\text{NO}$  Requires; C, 75.28; H, 11.28; N, 6.27%

Hydrogenation of  $\text{N-(1,1-dimethylpropargyl)-O-(3,3-dimethylallyl)-N-t-butylhydroxylamine}$  (39).

1. with Lindlar catalyst.

A solution of the acetylenic hydroxylamine (39) (30mg.) in benzene (1ml.) was hydrogenated at atmospheric pressure at room temperature over Lindlar catalyst (5mg.) After 24 hours, t.l.c. analysis (5% ether/60-80 petroleum ether) indicated that no significant reduction had occurred.

2. with 10% palladium/charcoal catalyst.

It proved to be extremely difficult to obtain reproducible conditions for hydrogenation with this catalyst. The reaction was evidently sensitive to minor changes in the amount of catalyst employed, quantity of solvent, rate of stirring and the size or shape of the vessel used.

A solution of the hydroxylamine (39) (20mg.) in 'Analar' benzene (2ml.) in a 5ml. B10 conical flask was hydrogenated at atmospheric pressure at room temperature over 10% palladium/charcoal (6mg.). The solution was stirred magnetically and after 45 minutes, t.l.c. analysis

(5% ether/60-80 petroleum ether), using authentic material for comparison, indicated complete conversion to the hydroxylamine (3). This product could be purified by preparative t.l.c. (5% ether/60-80 petroleum ether).

Catalytic reduction of  $N$ -(1,1-dimethylpropargyl)- $O$ -(3,3-dimethylallyl)- $N$ - $t$ -butylhydroxylamine (39) with deuterium

As with the previously described hydrogenation, considerable difficulty was encountered in obtaining reproducible conditions. In particular over-reduction often resulted from simply applying the conditions established for hydrogenation and to avoid this, it was found that considerably shorter reaction times could be successfully employed.

Thus to a solution of the hydroxylamine (39) (50mg.) in 'Analar' benzene (5ml.) in a 10ml. B10 conical flask was added 10% palladium/charcoal (15mg.). After evacuating the flask, deuterium was introduced from an electrolysis unit. Deuterium gas was generated at the cathode of an electrolysis unit containing a solution of  $D_2SO_4$  in  $D_2O$ . This procedure was repeated a further two times and with the deuterium at atmospheric pressure, the solution was stirred magnetically at room temperature for 4 minutes. Subsequent t.l.c. analysis (5% ether/60-80 petroleum ether) indicated a clean conversion to the reduced product (38). Preparative t.l.c. in the same solvent system allowed the isolation of this labelled product (25mg.).

$\tau(CDCl_3) = 8.89$  (9H, singlet)  $(\underline{CH}_3)_3-C-N$ , 8.76 (6H, singlet)  $(\underline{CH}_3)_2-C-N$ , 8.40 and 8.30 (both 3H, broadened

singlets),  $(\text{CH}_3)_2\text{-C=C}$ , 5.76 (2H, doublet,  $J=7\text{Hz.}$ ),  $-\text{O-CH}_2\text{-C=C}$ , 5.12 (1H, multiplet),  $\text{CDH=CD-}$ , 4.68 (1H, triplet,  $J=7\text{Hz.}$ ),  $-\text{CH}_2\text{-CH=C-}$ .

Thermolysis of labelled  $\text{N}$ -(1,1-dimethylallyl)- $\text{O}$ -(3,3-dimethylallyl)- $\text{N}$ - $t$ -butylhydroxylamine (38) in nitrobenzene

A solution of the labelled hydroxylamine (38) (20mg.) in nitrobenzene (1.5ml.) was heated at  $140^\circ\text{C}$  for 20 minutes. After cooling, sulpholane (5ml.) and petroleum ether (40-60, 15ml.) were added and the solution transferred to a separating funnel. After thorough shaking, the sulpholane extract was run off and discarded. Removal of solvent under reduced pressure from the petroleum ether extract yielded a residue which contained significant amounts of nitrobenzene. T.l.c. analysis (5% ether/60-80 petroleum ether) confirmed the presence of nitrobenzene as a major impurity in the rearranged hydroxylamine (42). Furthermore, since these two compounds had virtually identical  $R_f$  values, the isolation of a sufficient quantity of the pure hydroxylamine (42) by chromatography would be extremely difficult.

Thermolysis of  $\text{N}$ -(1,1-dimethylallyl)- $\text{O}$ -(3,3-dimethylallyl)- $\text{N}$ - $t$ -butylhydroxylamine (3) in dimethylformamide.

A solution of the hydroxylamine (3) (15mg.) in dry dimethylformamide (1ml.) was heated at  $140^\circ\text{C}$  for 20 minutes. After cooling, water (5ml.) and petroleum ether (40-60, 15ml.) were added and the solution transferred to a separating funnel. After thorough shaking, the aqueous layer was run off and discarded. T.l.c. analysis

(5% ether/60-80 petroleum ether) of the organic extract, using authentic material for comparison, indicated a complete and clean conversion to the hydroxylamine (2).

Thermolysis of labelled N-(1,1-dimethylallyl)-O-(3,3-dimethylallyl)-N-t-butylhydroxylamine (38) in dimethylformamide.

A solution of the labelled hydroxylamine (38) (35mg.) in dimethylformamide (2ml.) was heated at 140°C for 20 minutes. After cooling, water (5ml.) and petroleum ether (40-60, 15ml.) were added and the solution transferred to a separating funnel. After thorough shaking, the aqueous layer was run off and discarded. From the organic extract, the solvent was removed under reduced pressure to leave a wet residue. This material was taken up on chloroform and purified by preparative t.l.c. (5% ether/60-80 petroleum ether) to yield the labelled product (42) (24mg.).

$\tau(\text{CDCl}_3) = 8.87$  (9H, singlet),  $(\text{CH}_3)_3\text{-C-N}$ , 8.34 and 8.26 (both 6H, broadened singlets),  $(\text{CH}_3)_2\text{-C=C}$ , 6.73 (broadened doublet,  $J=7\text{Hz.}$ ),  $\text{C=CH-CH}_2\text{-N}$ , 5.83 (broadened doublet,  $J=7\text{Hz.}$ ),  $\text{C=CH-CH}_2\text{-O}$ , 4.68 (broadened quartet,  $J=7\text{Hz.}$ ),  $\text{-CH}_2\text{-CH=C}$ .

The resonances at  $\tau = 4.68$ , 5.83 and 6.73 integrate in the ratio 1: 1.29: 1.26 respectively.

REFERENCES.

1. R.B. Woodward and R. Hoffmann, Angew. Chem. Int. Ed. Engl., 8, 781, 1969.
2. J.A. Berson, Accounts Chem. Res., 1, 152, 1968.
3. H. Kwart and J. Slutsky, J. Amer. Chem. Soc., 94, 2515, 1972.
4. H. Kwart and N. Johnson, J. Amer. Chem. Soc., 92, 6064, 1970.
5. K.B. Sharpless and R.F. Lauer, J. Org. Chem., 37, 3973, 1972.
6. C.G. Overberger and A.E. Borchert, J. Amer. Chem. Soc., 82, 1007, 1960.
7. G.R. Branton and H.M. Frey, J. Chem. Soc., 1342, 1966 and references cited therein.
8. R.S. Atkinson and C.W. Rees, J.C.S. Chem. Comm., 1232, 1967.
9. D.G. Morris, J.C.S. Chem. Comm., 1345, 1969.
10. H.R. Ward, Accounts Chem. Res., 5, 18, 1972.  
R.G. Lawler, *ibid*, 5, 25, 1972.
11. H.R. Ward in Free Radicals Chap. 6, J.K. Kochi, Ed., Wiley Interscience, 1973.
12. J. Bargon, H. Fischer and U. Johnsen, Z. Naturforsch., 22a, 1552, 1967.  
J. Bargon and H. Fischer, *ibid.*, 22a, 1556, 1967.
13. H.R. Ward, J. Amer. Chem. Soc., 89, 5517, 1967.  
H.R. Ward and R.G. Lawler, *ibid.*, 89, 5518, 1967.
14. T.S. Stevens, E.M. Creighton, A.B. Gordon and M. MacNicol, J. Chem. Soc., 3193, 1928.
15. U. Schollkopf, U. Ludwig, G. Ostermann and M. Patsch, Tet. Lett., 3415, 1969.

16. J.E. Baldwin, W.F. Erickson, R.E. Hackler and R.M. Scott, J.C.S. Chem. Comm., 576, 1970.
17. A.R. Lepley, P.M. Cook and G.F. Willand, J. Amer. Chem. Soc., 92, 1101, 1970.
18. D.G. Morris, J.C.S. Chem. Comm., 221, 1971.
19. N.A. Porter and P.M. Iloff, J.C.S. Chem. Comm., 1576, 1971.
20. T. Koenig and H. Fischer in Free Radicals, Chap. 4, J.K. Kochi, Ed., Wiley Interscience, 1973.
21. P.D. Bartlett and S.F. Nelson, J. Amer. Chem. Soc., 88, 139, 1966.
22. E.G. Rozantsev, Free Nitroxyl Radicals, Plenum Press, 1970.
23. A.K. Hoffmann, E.G. Abraham and A.M. Feldman, U.S. Patent No. 3,372,182; 1968; C.A., 69, 43418j.
24. E.G. Rozantsev, Bull. Acad. Sci. USSR., 740, 1966.
25. E.A.F. Thomas, Deuterium Labelling in Organic Chemistry, Appleton-Century-Crofts, New York, 1971.
26. F. Scheinmann, R. Barner and H. Schmid, Helv. Chim. Acta., 51, 1603, 1968.
27. C. Mercier, Bull. Soc. Chim. France, 4545, 1969.